



Operation manual

Integral process thermostats

containing natural refrigerant

IN 550 XT, IN 550 XTW, IN 750 XT, IN 950 XTW, IN 1850 XTW

Manufacturer:

LAUDA DR. R. WOBSEER GMBH & CO. KG

Laudaplatz 1

97922 Lauda-Königshofen

Germany

Telephone: +49 (0)9343 503-0

E-mail: info@lauda.de

Internet: <https://www.lauda.de>

Translation of the original operation manual

Q4DA-E_13-036, 2, en_US © LAUDA 2024

replaces issues V2R10, V1R94, V1R93, V1R92, V1R91, V1R88

05/12/2026

Table of contents

1	Safety.....	7
1.1	Safety information.....	7
1.2	Obligations of the operator.....	9
1.3	EMC requirements.....	10
1.4	Software versions.....	10
1.5	Observing additional operating instructions.....	11
1.6	Limits of the device.....	11
1.6.1	Use.....	11
1.6.2	Ambient conditions and operating conditions.....	11
1.6.3	Time limits.....	12
1.6.4	Cooling water requirements.....	12
1.7	Prohibition of modifications to the device.....	12
1.8	Materials.....	12
1.9	Natural refrigerant.....	12
1.10	Heat transfer liquid requirements.....	14
1.11	Hose requirements.....	15
1.12	Personnel qualification.....	15
1.13	Personal protective equipment.....	15
1.14	Structure of warnings.....	16
1.15	Safety fittings on the device.....	16
1.15.1	Overtemperature protection.....	16
1.15.2	Low-level protection.....	17
1.15.3	Product safety label.....	17
2	Unpacking.....	18
3	Device description.....	21
3.1	Overall view of Integral IN XT.....	21
3.2	Mains switch and quick shutdown button.....	22
3.3	Hydraulic circuit.....	22
3.4	Rating label.....	24
3.5	Interfaces.....	26
4	Before starting up.....	28
4.1	Install device.....	28
4.2	Hoses.....	30
4.3	Connecting an external application.....	32
4.4	LAUDA heat transfer liquids.....	35
4.5	Cooling water requirements.....	37
4.6	Connecting the cooling water.....	38

4.7	Configuring interfaces.....	40
4.7.1	Potential-free contact (alarm output).....	40
4.7.2	Configuring the Ethernet interface.....	41
4.7.3	Data transfer rate.....	47
4.7.4	Protocol of the interface.....	48
4.7.5	Read commands.....	48
4.7.6	Write commands.....	54
4.7.7	Error messages.....	57
5	Commissioning.....	59
5.1	Establishing a mains connection.....	59
5.2	Switching on the device for the first time.....	60
5.3	Operating the device with the operating unit.....	62
5.3.1	Home window, navigation and softkeys.....	62
5.3.2	Enter entry window and set temperature.....	64
5.3.3	Graph window.....	65
5.3.4	Operating the device with the Command Touch.....	66
5.4	Setting the heat transfer liquid.....	67
5.5	Filling the device with heat transfer liquid.....	68
5.6	Filling an IN XT device.....	71
5.7	Degas heat transfer liquid (low boiling point expulsion).....	72
5.8	Setting the flow rate of the heat transfer liquid.....	74
6	Operation.....	77
6.1	General warnings.....	77
6.2	Operating modes.....	83
6.3	Menu structure.....	84
6.4	Setting the overtemperature switch-off point T_{max}	87
6.5	Set the setpoint offset.....	87
6.6	Limiting heating and cooling.....	88
6.7	Dead-time correction.....	89
6.8	Dynamic heat limiter.....	90
6.9	Cooling.....	90
6.10	Setting temperature limits T_{ih} and T_{il}	91
6.11	Lock and release operating buttons.....	91
6.12	Basic settings.....	92
6.13	Calibrating the temperature probe.....	95
6.14	Restore the factory setting.....	96
6.15	Viewing the Device status.....	97
6.16	Through-flow control of the internal heater.....	99
6.17	Programmer.....	100

6.17.1	Basic information.....	100
6.17.2	Set and process program.....	105
6.17.3	Creating and controlling ramps.....	107
6.18	Set time, date, format and time zone.....	111
6.19	Self adaptation, temperature control.....	112
6.20	Control parameters.....	113
6.20.1	Control basics.....	114
6.20.2	Overview of internal control parameters.....	116
6.20.3	Overview of external control parameters.....	117
6.20.4	Activate control variable.....	118
6.20.5	Change control parameters.....	119
6.21	Operator and viewer.....	119
6.22	Web server LAUDA Command.....	122
6.23	LAUDA.LIVE Cloud Service.....	125
6.24	Safe Mode safety fittings.....	127
6.25	Importing and exporting data.....	131
6.25.1	Importing data.....	131
6.25.2	Exporting data.....	131
7	Maintenance.....	134
7.1	Warning notes for maintenance.....	134
7.2	Maintenance intervals.....	134
7.3	Cleaning the device.....	135
7.4	Cleaning the air-cooled condenser.....	135
7.5	Cooling water circuit maintenance.....	137
7.6	Checking the overtemperature protection.....	138
7.7	Checking the low-level protection.....	139
7.8	Check the heat transfer liquid.....	140
8	Fault elimination and repair.....	143
8.1	Repair.....	143
8.2	Alarms, errors and warnings.....	143
8.3	Alarms.....	144
8.4	Troubleshooting.....	146
9	Decommissioning.....	149
9.1	Information on decommissioning.....	149
9.2	Drain the heat transfer liquid and clean the thermostatic circuit.....	149
9.3	Draining the cooling water circuit.....	151
10	Disposal.....	153
10.1	Disposing of packaging.....	153
10.2	Disposing of refrigerant.....	153

10.3	Device disposal.....	153
10.4	Disposing of heat transfer liquid and liquids.....	153
11	Accessories.....	154
12	General.....	155
12.1	Copyright.....	155
12.2	Technical changes.....	155
12.3	Warranty conditions.....	155
12.4	License texts.....	155
12.5	Contact LAUDA.....	156
13	Technical data.....	157
13.1	General.....	157
13.2	Heating output and power supply.....	159
13.3	Cooling output.....	160
13.4	Refrigerant and filling weight.....	162
13.5	Pump characteristics for IN XT.....	163
13.6	Electrical block diagram.....	164
14	Declaration of Conformity.....	165
15	Product Returns and Clearance Declaration.....	167
16	Glossary.....	168
17	Index.....	170

1 Safety

1.1 Safety information



IMPORTANT

- Before using the device, please read the operating manual carefully.
- The information in this operating manual must be kept close at hand in the immediate vicinity of the device.
- Keep the operating manual for future reference.
- This operating manual is part of the device. If the device is passed on, the operating manual must be kept with it.
- The operating manual is available on our homepage (<https://www.lauda.de>).



An overview of authorized personnel and protective equipment can be found in ↪ Chapter 1.12 “Personnel qualification” on page 15 and ↪ Chapter 1.13 “Personal protective equipment” on page 15.



Refer to ↪ Chapter 1.14 “Structure of warnings” on page 16 for more information on the general structure of warnings.

The "Safe State" of the constant temperature equipment in the event of overtemperature, low level or failure is defined as:

- Heating off.
- If you notice any damage to the transport packaging, store the device either in a well-ventilated place with no sources of ignition or outdoors. Contact LAUDA Service.
- The device and the inside of the device could be damaged:
 - due to fall,
 - due to shock.
- Do not tilt the device.
- Position the device on an even, non-slip surface with a sufficient load carrying capacity.
- Actuate the castor brakes when setting up the device.
- Do not place heavy parts on the device.
- The devices can only be operated as intended under the conditions specified in this operating manual. Any other mode of operation is considered to be unintended use and could compromise the protection provided by the device.
- You, the user, must check the functionality of the safety fittings of the device. The maintenance intervals must be complied with for this purpose.
- The device may only be operated by trained personnel.
- Do not install the device in areas with aggressive media.
- Keep the specified distance from other devices, objects or walls.
- Do not store any liquids or flammable objects above the device.
- Do not handle flammable liquids in the immediate vicinity of the device.

- Hoses and application:
 - The temperature and media resistance of the hoses must be suitable for the application.
 - Use hoses with a greater compressive strength than the maximum possible pump pressure.
 - For liquids with a density above 1 kg/dm^3 , the pump pressure must be converted according to the density.
 - Use pressure-resistant external applications or safety valves to prevent gauge pressure in the hydraulic circuit.
 - When laying the hoses for the application, make sure that the hoses cannot be kinked or crushed.
 - Always use hydraulically sealed applications.
- Overflow hose and drainage hose must each slope downward separately all the way into a collecting vessel.
- If the application is located in a lower position and is sensitive to pressure, also take into account the additional pressure resulting from the difference in height between the application and the device. For pressure-sensitive applications (for example, glass apparatus) with a maximum permissible working pressure below the maximum pressure of the pump (see Technical data section), the hoses of the application must be laid in such a way that bending or squeezing is not possible. In addition, a separate safety pressure relief valve for preventing gauge pressure must be installed in the outflow of the thermostatic circuit to protect against operating errors. Adjust the pump pressure with the bypass according to your application.
- Select a heat transfer liquid with a temperature range suitable for the application.
- The devices are intended for operation on centrally grounded networks. Operation on IT networks, for example, is not permitted.
- Make sure that the aeration openings are not blocked.
- Do not smoke! No naked flames!
- When working near the process thermostat and the application, do not use electrical parts that can generate sparks.
- Keep the cover of the expansion vessel closed during operation.
- For the responsible department of the operator: Attach the warning symbol WO21 "Warning: flammable substances" (included in the accessories) to the device in a clearly visible location.
- Do not operate the device without heat transfer liquid.
- Switch off the device and pull out the mains plug,
 - before starting service or repair work,
 - when moving the device,
 - when installing or removing interface modules or accessories.
- Only certified specialists who are trained to handle flammable refrigerants are authorized to perform repair and disposal work. In order to avoid the risk of possible ignition due to incorrect maintenance or the installation of incorrect parts, only specialists certified by the manufacturer are authorized to carry out maintenance.
- Any components and parts must be replaced with identical parts.
- Never dispose of a cooling circuit that is still pressurized.
- Drain the device completely before moving it.
- Do not make any technical modifications to the device.
- The devices are not approved for use in medical environments.

- Do not switch on the device at the main switch until all hydraulic connections for the application have been fully established and all measures for safe commissioning have been implemented.
- Always wear suitable safety glasses when working on the device.
- Use insulated hoses at temperatures below 0 °C or above 70 °C. The surface temperatures of some device parts (e.g. pump or drain nozzles) can reach 70 °C at higher operating temperatures (possible risk of burns).
- Use tubing clips to prevent the hoses from slipping off the hose nozzle.
- Check the hoses from time to time for possible material fatigue. If a hose breaks hot liquids may leak out, thus endangering people and materials.
- The mains cable must not come into contact with hoses containing heat transfer liquid or other hot parts.
- The following actions may unintentionally restart the thermostat from standby,
 - previously activated timer operation,
 - 'Start' command over active interfaces on the device.
- Observe the permissible storage and operating temperatures of the device.
- The device may only be operated with the casing mounted.
- Bring the heat transfer liquid to room temperature before draining.
- When changing to another heat transfer liquid, clean the device intensively and drain it completely. It is recommended to flush the device with the new heat transfer liquid.
- Never replenish hot heat transfer liquid with other fluids.
- The ingress of secondary liquids into the device (e.g. through a faulty heat exchanger provided by the customer) must be prevented at all costs.
- Observe all product safety labels/safety marks on the device.

Additional safety information for water-cooled devices

- Use suitable cooling water to prevent corrosion in the cooling water circuit.
- Secure the water cooling return hose in the outlet area to prevent the hose from jerking suddenly, even when pressure surges occur.
- The return hose of the water cooling system must be fixed in the outlet area in such a way that hot cooling water cannot splash out.
- Avoid bending or squeezing the return hose of the water cooling system. Gauge pressure can cause the cooling water hoses to rupture and hot cooling water to escape.
- In order to avoid damage caused by leakage of the cooling water system, it is recommended to install a leakage water detector with water shut-off.

1.2 Obligations of the operator

Observe the national regulations relating to the operation of constant temperature equipment in your country.



In particular, the application of statutory regulations concerning operational safety must be observed.

Ensure that the minimum room size requirements are met, see chapter Technical Data.

1.3 EMC requirements

Table 1: Classification in accordance with EMC requirements

Device	Immunity requirements	Emissions class	Customer power supply
Integral IN XT(W)/PW	Table 2 (Industrial) in accordance with EN 61326-1	Emissions Class B in accordance with CISPR 11	Only for EU Domestic connection value ≥ 100 A*
Integral IN XT(W)/PW	Table 2 (Industrial) in accordance with EN 61326-1	Emissions Class B in accordance with CISPR 11	Rest of the world (outside EU) No limitation

*** Only for Integral IN 1850 XTW:**

EN 61000-3-12:2011-compliant Class B for short-circuit power $S_{sc} \geq 1.2$ MVA at the connection point ($R_{scc} = 90$). The installer/operator must ensure that this condition is met. Otherwise compliance with Class A.

Instructions for Class A digital device, USA

"This equipment has been tested and found to comply with the limits for Class A digital device, pursuant to Part 15 of the FCC (Federal Communication Commission) Rules. These limits are designed to provide reasonable protection against harmful interference when the equipment is operated in a commercial environment. This equipment generates, uses, and can radiate radio frequency energy and, if not installed and used in accordance with the instruction manual, may cause harmful interference to radio communications. Operation of this equipment in a residential area is likely to cause harmful interference in which case the user will be required to correct the interference at his own expense."

Instructions for Class A digital device, Canada

"This Class A digital apparatus complies with Canadian ICES-003" (ICES = Interference Causing Equipment Standards).

« Cet appareil numérique de la classe A est conforme à la norme NMB-003 du Canada ».

1.4 Software versions

This operating manual is valid for devices with the following software versions or higher.

Software	Valid from version
Control system	1.60
Safety	1.25
Cooling	2.00
Heating	1.25

Software	Valid from version
Pump	2.63
External temperature	1.48

1.5 Observing additional operating instructions

Interface modules

Additional interface modules can be fitted to the device. Before installing and using interface modules, always read and observe the operating manual accompanying the relevant interface module.

1.6 Limits of the device

1.6.1 Use

Intended use

This device may only be used for the temperature control and circulation of flammable and non-flammable heat transfer liquids through a closed circuit.

Reasonably foreseeable improper use

The following are considered cases of reasonably foreseeable misuse:

Operating the device...

- without heat transfer liquid
- with an unsuitable heat transfer liquid
- with incorrectly connected hoses
- with an incorrect pump pressure setting
- for medical applications
- Use in hazardous areas
- Use for controlling the temperature of foodstuffs
- Operation with a glass reactor without gage pressure protection
- with a non-closed hydraulic circuit
- in an outdoor installation

Type of power supply

The device is supplied with...

- Electrical energy (each device)
- Compressed air (certain devices)

Additional process medium

- Cooling water (required for water-cooled process thermostats and high-temperature thermostats)

Performance limits, operating values

- See ↗ Chapter 13 “Technical data” on page 157

1.6.2 Ambient conditions and operating conditions

The device may only be used in the following areas:

- Production, quality assurance, research and development in an industrial environment
- Only used inside buildings
- Use up to a height of 2,000 m above sea level

- Ambient temperature from 5°C to 40°C
- Maximum relative humidity 80% at temperatures up to 31°C, linearly decreasing until 50% relative humidity at 40°C.
- Fluctuations of the mains voltage up to $\pm 10\%$ of the nominal voltage.
- Transient electrical surge up to the values of the surge category II
- Sporadic electric surges that occur in the mains power supply
- Pollution degree 2

1.6.3 Time limits

- Service life - The device is designed for 20,000 operating hours.
- Maintenance intervals -  Chapter 7.2 "Maintenance intervals" on page 134

1.6.4 Cooling water requirements

Cooling water is subject to specific purity requirements. A suitable procedure must be employed to purify the cooling water in line with the contamination in the water and maintain the water quality.

1.7 Prohibition of modifications to the device

Any technical modification of the device by the user is prohibited. Any damage resulting from unauthorized modification is not covered by customer service or the product warranty. Service work may only be performed by the LAUDA Service department or a service partner authorized by LAUDA.

1.8 Materials

All parts that come into contact with heat transfer liquid are manufactured from high-quality materials adapted to withstand the operating temperature. High-quality stainless steels, copper, brass and premium-quality heat-resistant plastics are used.

1.9 Natural refrigerant

The devices are filled with natural refrigerant from safety group A3 and the filling quantity is above 0.15 kg. These natural refrigerants are highly flammable.



According to DIN EN 378-1, the refrigeration system is a "sealed refrigeration system".

All parts carrying refrigerant are tightly installed by welding, brazing or similar permanent joints. Service connections are fitted with caps. The refrigeration system also has a tested leakage rate of less than 3g per year at a minimum of one quarter of the maximum permissible pressure.



DANGER!
Formation of a flammable atmosphere

Explosion, burns, fire

- Avoid ignition sources in the immediate vicinity.
- The maintenance and calibration periods specified by the manufacturer for the gas warning sensor must always be observed. The gas warning sensor must be replaced at the end of its service life, see chapter "Maintenance". However, local regulations may stipulate the need for earlier periodic testing and/or calibration.
- If the gas warning sensor triggers, a specialist trained in handling flammable refrigerants must identify and rectify the cause. Only then can the system be recommissioned.
- Ensure that the minimum room size requirements are met, see chapter Technical Data. If the room size does not meet the minimum requirements, additional measures must be implemented. For example, installation in the machinery room or outdoors.



WARNING!
Leaks in the cooling circuit

Burns, fire

- Do not use corrosive heat transfer liquids.



WARNING!
Bursting of the cooling circuit

Burns, fire

- Ensure that none of the openings on the fan are blocked, including the front air inlet of the device and the air outlets.

Gas warning sensor

The integral gas warning sensor triggers an automatic shutdown if a predefined threshold corresponding to 25% of the Lower Flammability Limit (LFL) is exceeded.

The LED on the gas warning sensor (visible through the ventilation slots) lights up red.

If the gas warning sensor triggers, a specialist trained in handling flammable refrigerants must identify and rectify the cause. Only then can the system be recommissioned.

If the gas concentration is between 10% and 25% of the Lower Flammability Limit (LFL), a warning (Warning 042 "Gas detected") is stored in the error memory and shown on the display. The gas warning sensor flashes red.

Before an automatic safety shutdown is triggered, this warning is shown on the display and stored in the error memory. There is no separate error message for an automatic shutdown (device switches off immediately).



Notes:

- *The device only switches on when the gas warning sensor does not detect a dangerous refrigerant concentration.*
- *The gas warning sensor flashes green rapidly during initialization.*
- *The gas warning sensor flashes green slowly when a gas concentration is not detected.*

Quantity of refrigerant

With consideration for the category of the access area in buildings, each circuit may contain a maximum of 1 kg of flammable refrigerant according to EN 378-1. This applies to basements in monitored access areas (such as laboratories, offices or business premises, premises for general manufacturing and work purposes). For ground floors and upper floors, the maximum filling quantity in the monitored access area is 2.5 kg. It is the operator's responsibility to use the interfaces provided on the device according to any risk assessments conducted (e.g. evacuation of the room, shutdown of ignition sources in the room). The device can only detect the presence of an explosive atmosphere when energized.

The refrigerant designation and charge are specified on the type plate and in the [Chapter 13.4 "Refrigerant and filling weight"](#) on page 162.

Note the installation conditions outlined in ["Installation location"](#) on page 158.

1.10 Heat transfer liquid requirements

- Heat transfer liquids are used to control the temperature. LAUDA heat transfer liquids are recommended for the constant temperature equipment. LAUDA heat transfer liquids have been tested by the company LAUDA DR. R. WOBSE GMBH & CO. KG and approved for this device.
- The heat transfer liquids are suitable for a specific temperature range. This temperature range must correspond to the temperature range of your application.
- The safety data sheet of the heat transfer liquid specifies potential hazards and the corresponding safety measures required for handling the liquid. The safety data sheet of the heat transfer liquid must therefore be observed to ensure proper use of the device.
- If you wish to use your own heat transfer liquids, check that the fluids are suitable for the materials used.
- The heat transfer liquid must be provided with corrosion protection.
- You must also check the suitability of the heat transfer liquid by performing a test run within the desired temperature range.

- The device is designed for flammable and non-flammable heat transfer liquids according to class FL as per DIN 12876.

1.11 Hose requirements

The

- temperature,
- pressure and
- media resistance of the hoses must be suitable for the respective application.

Refer to Chapter ↗ Chapter 4.2 “Hoses” on page 30 for information on recommended hoses.

1.12 Personnel qualification

Certified specialist

Specialist who is certified and authorized to perform specific work.

Operating personnel

Operating personnel are personnel who have been instructed by qualified personnel on how use the device as intended in line with the information in the operating manual.

Specialized personnel

Certain activities on the device must be performed by specialized personnel. Specialized personnel are people whose professional education, knowledge, and experience as well as knowledge of relevant standards qualify them to assess the function and risks associated with the device and its use.

1.13 Personal protective equipment



Protective gloves

Protective gloves must be worn for certain tasks. The protective gloves must comply with standard DIN EN ISO 374-1. The protective gloves must be chemically resistant.



Protective work clothing







Protective clothing must be worn for certain tasks. This protective clothing must meet the legal requirements for personal protective equipment. Protective clothing with long sleeves must be worn. Additionally safety shoes are required.



Safety glasses

Safety glasses must be worn for certain tasks. The safety glasses must comply with the standard DIN EN 166. The glasses must be tightly closed and equipped with side plates.

1.14 Structure of warnings

Warning signs	Type of danger
	Warning – dangerous electrical voltage.
	Warning – explosive substances.
	Warning – flammable substances.
	Warning – hot surface.
	Warning – slip hazard.
	Warning – danger zone.

Signal word	Meaning
DANGER!	This combination of symbol and signal word indicates an imminently dangerous situation that will result in death or serious injury if it is not avoided.
WARNING!	This combination of symbol and signal word indicates a potentially dangerous situation that can result in death or serious injury if it is not avoided.
CAUTION!	This combination of symbol and signal word indicates a possible dangerous situation that can result in minor injury if it is not avoided.
NOTICE!	This combination of symbol and signal word indicates a potentially dangerous situation that can result in material and environmental damage if it is not avoided.

1.15 Safety fittings on the device

1.15.1 Overtemperature protection

Overtemperature protection

The overtemperature protection is a safety fitting that prevents flammable heat transfer liquid from igniting due to high temperatures. If the preset maximum temperature (T_{max}) is exceeded, all safety-relevant components on the device are switched off to prevent the risk of fire. An alarm signal also indicates that the overtemperature protection has been activated. The temperature at which the safety fitting (T_{max}) is activated must be set in line with the heat transfer liquid used.

Repeat the checks of the overtemperature protection at regular intervals.



Further information ↪ Chapter 7.2 “Maintenance intervals” on page 134 and ↪ Chapter 7.6 “Checking the overtemperature protection” on page 138.

1.15.2 Low-level protection

Low-level protection

The low-level protection is a safety fitting that prevents damage to the device and prevents the heaters from igniting flammable heat transfer liquid. If the fill level of the heat transfer liquid in the device falls below a specified level, a warning is issued initially. If the fill level continues to fall, an alarm is triggered. All safety components on the device are switched off as a result.

Repeat the checks of the low-level protection at regular intervals.



Further information ↪ Chapter 7.2 “Maintenance intervals” on page 134 and ↪ Chapter 7.7 “Checking the low-level protection” on page 139.

1.15.3 Product safety label

Hot



A "Hot surface" graphical symbol is affixed to the device. This symbol warns against hot surfaces on the device. These surfaces must not be touched during operation. These surfaces must be allowed to cool to room temperature before they can be touched during other operation phases such as servicing.

Danger zone



A "Danger zone" graphic symbol is affixed to the device. This symbol warns of a possible danger zone on the device, which may pose an impending or imminent danger to the life and health of personnel.

A "flammable substances" graphic symbol is affixed to the device. This symbol warns of a possible danger zone on the device, which may pose an impending or imminent danger to the health of personnel.

2 Unpacking

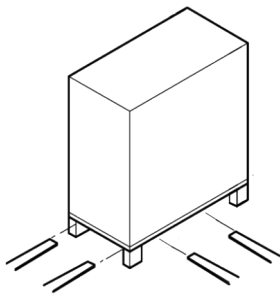

Fig. 1: Transport with forklift truck



WARNING!
Leaks in the cooling circuit due to transport damage

Fire

- If you notice any damage to the transport packaging, store the device either in a well-ventilated place with no sources of ignition or outdoors. Contact LAUDA Service.

Personnel: ■ Operating personnel

Check the device and accessories for completeness and transport damage immediately after delivery.



If the device or accessories are damaged contrary to expectations, immediately inform the shipping company so that a damage report can be compiled and the transport damage inspected. Also notify the LAUDA Service department immediately. You will find the contact information here ↗ Chapter 12.5 “Contact LAUDA” on page 156.



Keep the original packaging of your constant temperature equipment for subsequent transportation.

Unpack the device according to the following instructions.

1. **Fig. 1:** Cut and remove the strapping ①.
2. Lift the cover of the cardboard box ② and remove it.
3. Unscrew the bayonet locks ③ from the box. Turn them counterclockwise to perform this task.
4. Remove the box ④.
5. **Fig. 2:** Unscrew the screws ⑤ from the wooden cover. Turn them counterclockwise to perform this task. Remove the wooden cover ⑥.
6. **Fig. 3:** The device is bolted to the transport pallet with steel angles. Unscrew the screws ⑦ from the bottom of the device. Swivel the castors to the side so that they do not get caught on the angle when lifting the device.

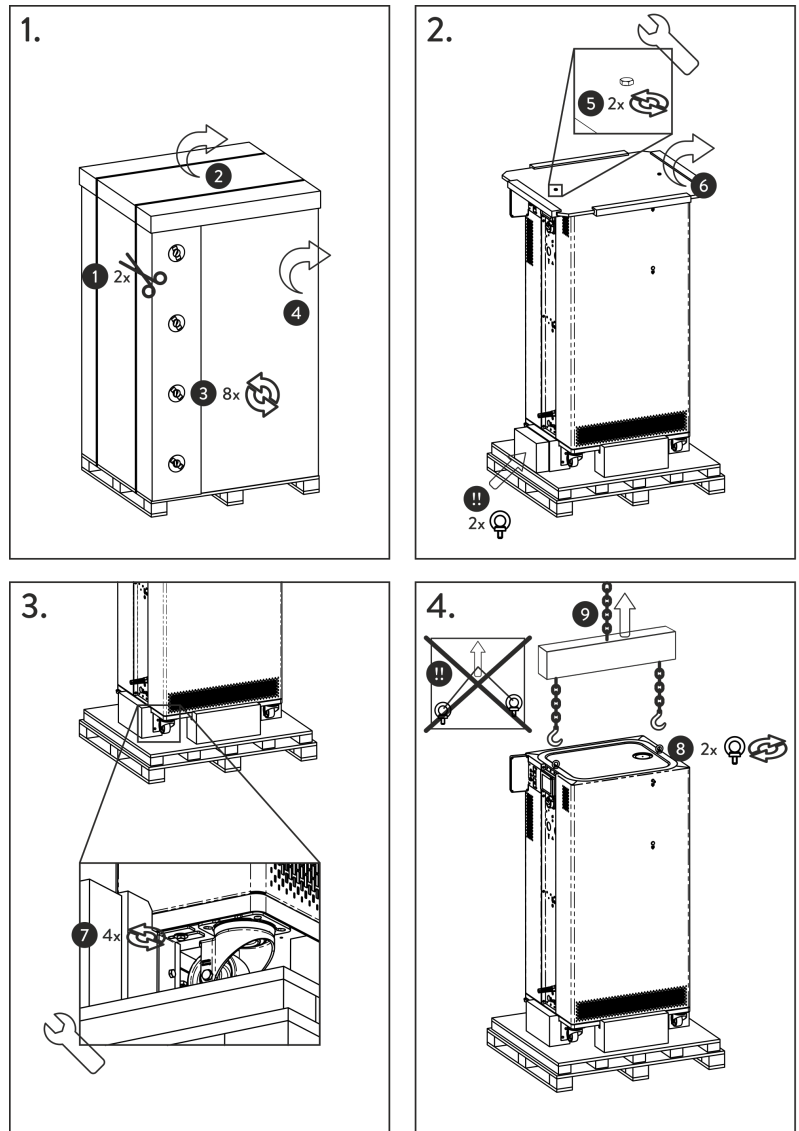

Fig. 2: Unpacking instructions

7. Fig. 2: Remove the ring bolts from the packaging.
8. Fig. 4: Screw the two ring bolts all the way into the thread connection Ⓢ (M10 or M16) on the top of the casing. Turn them clockwise to do so.



Fig. 3: Ring bolt (example)

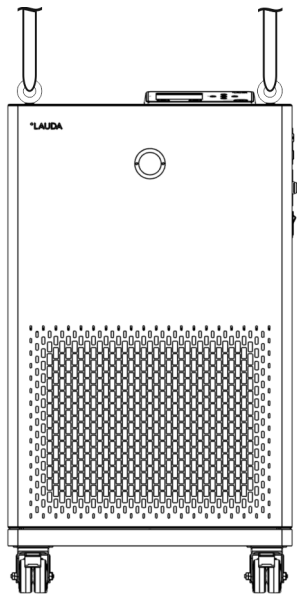



Fig. 4: Lift device

9. Use one permissible (textile) round sling, chain, steel cable or similar for each ring bolt. Attach the round slings securely to the crossbeam.
10. Align the round slings parallel to one another and at right angles to the top of the device. The crossbeam  must be parallel with the top of the device.

 *An inclined arrangement of the round slings is not permitted. Use a crossbeam.*

11. Use a crane to lift the device off the transport pallet.



 *The unpacking instructions can also be used for repacking.*

Table 2: Standard accessories for Integral IN XT

Device type	Designation	Quantity	Catalog number
All devices	Operating manual	1	Q4DA-E_13-036
All devices	Mains cable	1	---
IN 550 XT, IN 550 XTW, IN 750 XT, IN 950 XTW, IN 1850 XTW	Ring bolt M10 x 17 (higher load capacity)	2	DSS 085
All devices	Hose nozzle with union nut for drain nozzle	1	EOA 078
Water-cooled devices	Hose fitting for cooling water nozzle	2	EOA 001
All devices that are used with flammable heat Transfer liquids. Observe the general warning  "Use of flammable heat transfer liquids" on page 80.	"Flammable substance" warning sticker 	1	EZB 792

3 Device description

3.1 Overall view of Integral IN XT

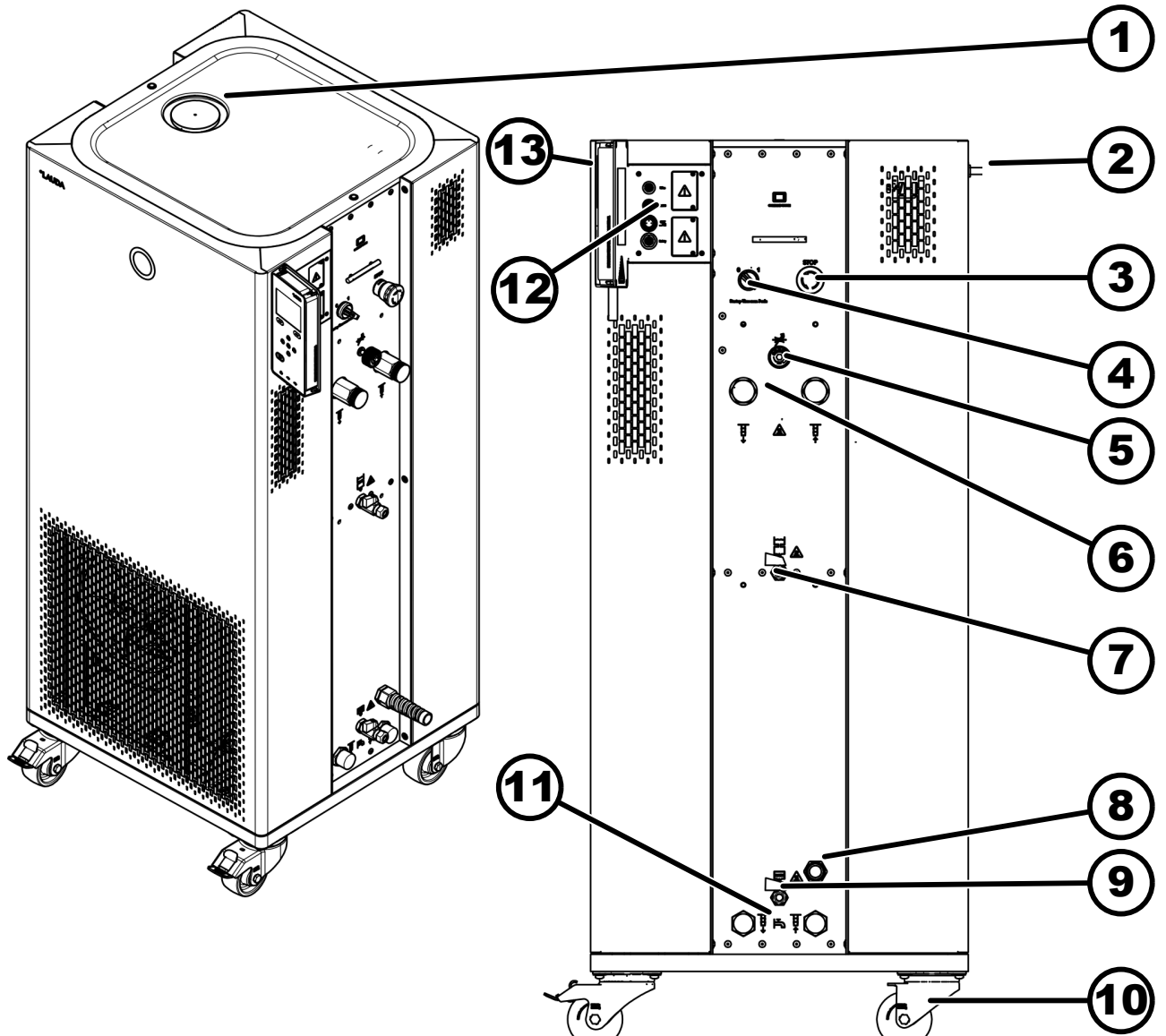

Fig. 5: Overview and side view of Integral IN 950 XTW

- | | |
|--|--|
| 1 Filler nozzle with cover | 8 Mains cable |
| 2 Overflow pipe on the rear of the device | 9 Drain nozzle with drain tap for the hydraulic circuit |
| 3 Quick shutdown button | 10 Four castors with parking brake |
| 4 Mains switch | 11 Connecting sleeve for cooling water (only water-cooled devices) |
| 5 Adjusting wheel for bypass valve | 12 Interfaces and two slots for interface module |
| 6 Pump connector (Left: outflow; Right: outlet) | 13 Operating unit with type plate on the back |
| 7 Drain nozzle with drain tap for expansion vessel (from Integral IN 550 XT) | |

3.2 Mains switch and quick shutdown button

The devices have a mains switch on the right side of the device. This is a rotary switch. Position [0] switches the device off, position [I] switches it on. After turning off the mains switch, it may take up to three seconds for the device to turn off.

The devices also have a quick shutdown button that switches the device off immediately.



Make sure that the quick shutdown button is not pressed when actuating the mains switch, otherwise the device will not start.



Mains switch on the three-phase device

The automatic fuse may only be switched on by a qualified electrician!

The rotary switch is not designed as a safety switch. The three-phase device has a separate automatic fuse built in. If the automatic fuse trips, contact the LAUDA Service department.

3.3 Hydraulic circuit

Hydraulic circuit in Integral IN XT

The hydraulic circuit in the Integral IN XT consists of a piping system through which the heat transfer liquid flows under pressure.

All devices are equipped with an 8-stage, hermetically sealed (magnetically coupled) pump. The pump performance can thus be optimally adapted to the respective task: High pump pressure, if, for example, long hoses lead to the external consumer.

As an alternative to the 8 power stages, operation with pressure control is provided. The pressure control enables a very effective supply of pressure-sensitive glass reactors with maximum permissible pressurization.

In the event of a fault, large quantities of heat transfer liquid can flow back into the device from the external circuit. In order not to flood the appliance, the expansion vessel has an overflow pipe.

In the heating-up area the pump works up to a kinematic viscosity of 200 mm²/s. 50 mm²/s should not be exceeded during regular operation. Optimum temperature control is under 30 mm²/s.

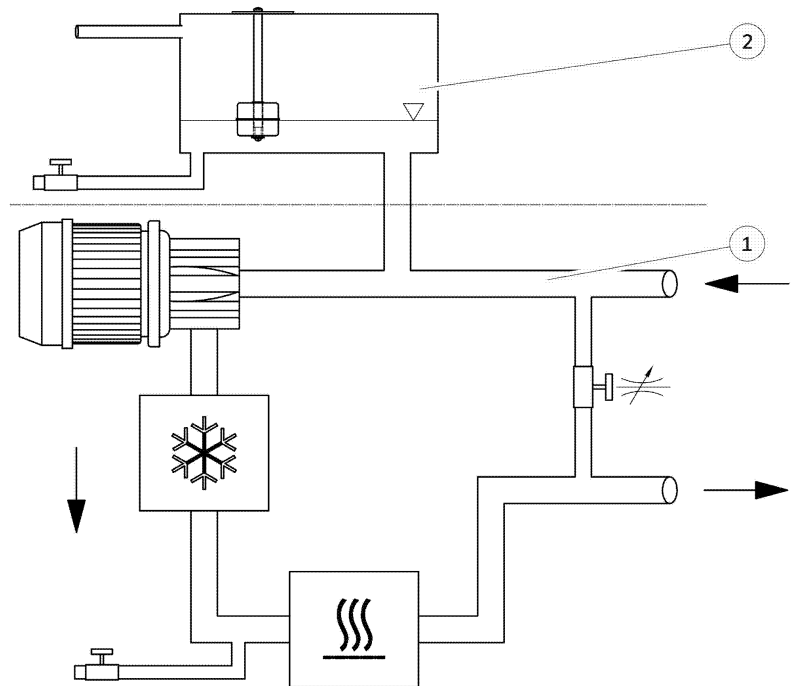

Fig. 6: Schematic of hydraulic circuit

- 1 Temperature-controlled
- 2 Not temperature-controlled

The hydraulic circuit in the device consists of the following components:

- Piping system
- Expansion vessel (not flowed through)
- Level sensor
- Pump
- Bypass
- Heating
- Evaporator

External hydraulic circuit

The external application is connected with hoses to the pump connectors of the device.

Only external applications with closed thermostatic circuits can be used on the Integral devices. Direct temperature control of open baths is not possible.

If the external temperature control volume exceeds the expansion volume in the Integral, a return flow of heat transfer liquid from higher-level consumers in the event of a fault or unintentional ventilation must be prevented with a reverse flow protection device.

The external hydraulic circuit consists of the following components:

- Hoses
- external application
- shut-off valves, if necessary

3.4 Rating label

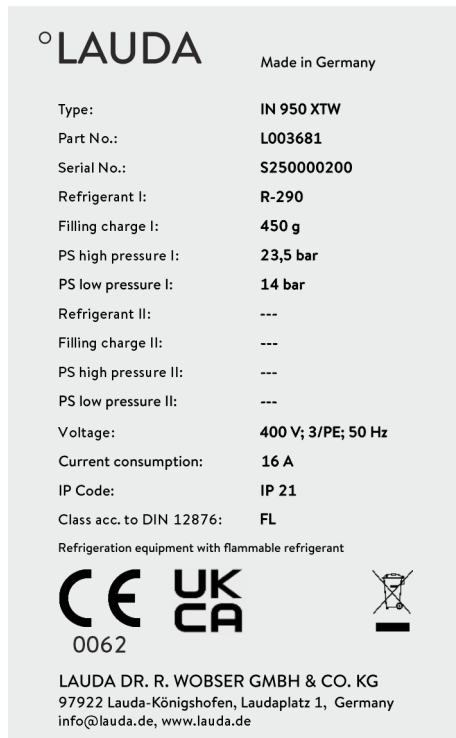

The serial number of a LAUDA device is made up as follows:

- the letter S,
- the year of manufacture (represented by two digits),
- and a 7-digit number.

The specifications on the type plate are described in more detail in the following table. Certain specifications depend on the equipment installed.

Furthermore, the type plates of the other device types are shown below.

Fig. 7: Type plate (example IN 950 XTW)

Table 3: Information on the type plate

Specification	Description
Type:	Type of device
Part No.:	Catalog number of the device
Serial No.:	Serial number of the device
Refrigerant I:	Refrigerant used in cooling circuit 1 of the appliance for cooling.
Filling charge I:	Filling weight of refrigerant
PS high pressure I:	Maximum permissible working pressure on the high-pressure side of the cooling circuit (compression, condensation)
PS low pressure I:	Maximum permissible working pressure on the low-pressure side of the cooling circuit (expansion, evaporation)
Refrigerant II:	Refrigerant used in cooling circuit 2 of the appliance for cooling.
Filling charge II:	Filling weight of refrigerant in the second stage.
PS high pressure II:	Maximum permissible working pressure on the high-pressure side of the cooling circuit (compression, condensation)
PS low pressure II:	Maximum permissible working pressure on the low-pressure side of the cooling circuit (expansion, evaporation)
Voltage:	Permissible power supply
Current consumption:	Current consumption of the device

Specification	Description
Protection class:	IP protection level of the device
Class acc. to DIN 12876:	Classification according to DIN 12876

Table 4: Type plates of other device types

<p>LAUDA Made in Germany</p> <p>Type: IN 550 XT Part No.: L004069 Serial No.: S250000204 Refrigerant I: R-290 Filling charge I: 350 g PS high pressure I: 23,5 bar PS low pressure I: 14 bar Refrigerant II: --- Filling charge II: --- PS high pressure II: --- PS low pressure II: --- Voltage: 400 V; 3/PE; 50 Hz Current consumption: 16 A IP Code: IP 21 Class acc. to DIN 12876: FL</p> <p>Refrigeration equipment with flammable refrigerant</p> <p>   0062</p> <p>LAUDA DR. R. WOBSEER GMBH & CO. KG 97922 Lauda-Königshofen, Laudaplatz 1, Germany info@lauda.de, www.lauda.de</p>	<p>LAUDA Made in Germany</p> <p>Type: IN 550 XTW Part No.: L004070 Serial No.: S250000203 Refrigerant I: R-290 Filling charge I: 450 g PS high pressure I: 23,5 bar PS low pressure I: 14 bar Refrigerant II: --- Filling charge II: --- PS high pressure II: --- PS low pressure II: --- Voltage: 400 V; 3/PE; 50 Hz Current consumption: 16 A IP Code: IP 21 Class acc. to DIN 12876: FL</p> <p>Refrigeration equipment with flammable refrigerant</p> <p>   0062</p> <p>LAUDA DR. R. WOBSEER GMBH & CO. KG 97922 Lauda-Königshofen, Laudaplatz 1, Germany info@lauda.de, www.lauda.de</p>
<p>LAUDA Made in Germany</p> <p>Type: IN 750 XT Part No.: L004063 Serial No.: S250000202 Refrigerant I: R-290 Filling charge I: 350 g PS high pressure I: 23,5 bar PS low pressure I: 14 bar Refrigerant II: --- Filling charge II: --- PS high pressure II: --- PS low pressure II: --- Voltage: 400 V; 3/PE; 50 Hz Current consumption: 16 A IP Code: IP 21 Class acc. to DIN 12876: FL</p> <p>Refrigeration equipment with flammable refrigerant</p> <p>   0062</p> <p>LAUDA DR. R. WOBSEER GMBH & CO. KG 97922 Lauda-Königshofen, Laudaplatz 1, Germany info@lauda.de, www.lauda.de</p>	<p>LAUDA Made in Germany</p> <p>Type: IN 1850 XTW Part No.: L004064 Serial No.: S250001234 Refrigerant I: R-1270 Filling charge I: 925 g PS high pressure I: 23,5 bar PS low pressure I: 23,5 bar Refrigerant II: --- Filling charge II: --- PS high pressure II: --- PS low pressure II: --- Voltage: 400 V; 3/PE; 50 Hz & 460 V; 3/PE; 60 Hz Current consumption: 25 A IP Code: IP 21 Class acc. to DIN 12876: FL</p> <p>Refrigeration equipment with flammable refrigerant</p> <p>   0062</p> <p>LAUDA DR. R. WOBSEER GMBH & CO. KG 97922 Lauda-Königshofen, Laudaplatz 1, Germany info@lauda.de, www.lauda.de</p>

3.5 Interfaces

Standard interfaces

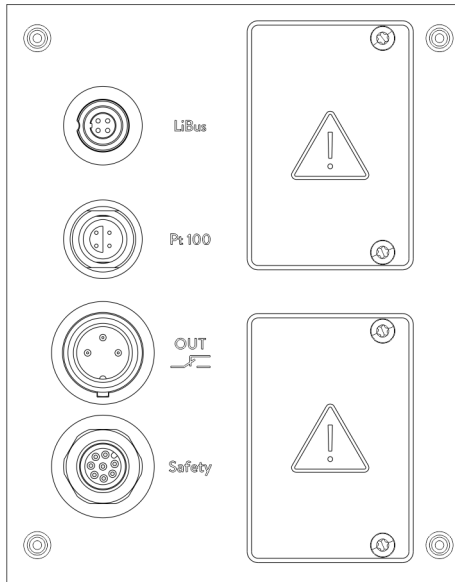

Fig. 8: Interfaces (on the side behind the operating unit)

- The **LiBus interface** (marked with the label **LiBus**) enables the connection of LAUDA accessories. Different solenoid valves (cooling valve, automatic filling device, shut down valve) or the LiBus module box can be connected.
- The external Pt100 temperature probe is connected to the **Pt100 interface** (marked with the label **Pt100**).
- **Potential-free contact** (marked with label **OUT**), with built-in connector (as per NAMUR NE 028) for program-segment controlled signal transmission for freely selectable peripheral functions to be activated (e.g. alarm).
- **Safety interface**
 - Pin 1/2: input, potential-free contact. The device can be switched off via pin 1 and pin 2 of the safety interface (same as the quick shutdown button).
Contact closed → device can be operated
Contact open → device is switched off
 - Pin 7/8: output, potential-free contact, state of the main contactor, contact is closed when main contactor is closed. The device status (on/off) can be read via pin 7 and pin 8.

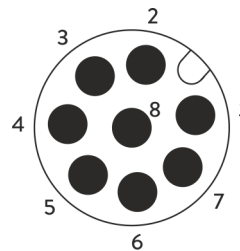

Fig. 9: Pin assignment of the safety interface

View of the interface or into the connector on the solder side.

i *When the safety interface is not being used, the short-circuit plug must be plugged into the safety interface! Otherwise the device will not start.*

There are other interfaces located underneath the operating unit:

- **USB interface device** (type B). Software updates (updater) are installed on the device via this interface (not a process interface).
- The (type A) **USB interface host** enables connection of a USB stick. This interface can be used, for example, for data imports, data exports and software updates (not a process interface).
- The **Ethernet interface** enables the connection to a control station or a PC. This interface offers the customer the opportunity to control and monitor their temperature control processes via a LAUDA interface command set (process interface).

Accessories interface module

Different interface modules can be installed in the devices:

- The **analog module** (order no. LRZ 912) has a 6-pin socket with two inputs and two outputs. The inputs and outputs can be configured as a 0 – 20 mA, 4 – 20 mA or 0 – 10 V interface independently of one another. A voltage of 20 V applied to the socket supplies power to an external sensor with electronic evaluation unit.
- **Pt100 LiBus module** (order no. LRZ 925) with a Lemo socket (label: Pt100) for an external Pt100 temperature probe. The LiBus socket (label: LiBus) serves to connect components via the LAUDA device bus.
- The **RS 232/485 interface module Advanced** (order no. LRZ 926) is available in a 9-pin D-SUB socket design. Galvanically isolated by an optocoupler. The RS 232 interface can be connected directly to the control station or PC using a 1:1 contacted cable.
- The **contact module Advanced** (order no. LRZ 927) is available in a plug connector design according to NAMUR NE28. This contact module is identical to LRZ 915 but only has 2 sockets each with 1 output and 1 input. The coupling socket (order no. EQD 047) and the coupling connector (order no. EQS 048) have a 3-pin design.
- The **contact module Advanced** (order no. LRZ 928) is available in a 15-pin D-SUB socket design. With three relay contact outputs (change-over contacts, maximum 30 V/0.2 A) and three binary inputs for control via external potential-free contacts.
- **Profibus module Advanced** (order no. LRZ 929). Profibus is a bus system used primarily in the chemical industry, which can connect a maximum of 256 devices at a high signal transmission rate.
- **EtherCAT module Advanced** (order no. LRZ 931) with M8 connection sockets. EtherCAT is an Ethernet-based field bus with master/slave functionality.
- **Profinet module Advanced** (order no. LRZ 932), each with two 8-pin RJ45 sockets. Profinet is an industrial Ethernet-based communication protocol that enables fast, reliable data transmission between automation components in industrial networks.
- **CAN module Advanced** (order no. LRZ 933) with 9-pin D-Subminiature socket. CAN is a robust, serial bus system for networking control units in industrial applications that offers a high degree of transmission reliability and resistance to interference.
- **OPC UA module Advanced** (order no. LRZ 934) with 8-pin RJ45 socket. The OPC UA server enables secure, standardized communication as well as easy integration of LAUDA constant temperature equipment into higher-level systems such as MES or SCADA.
- **Modbus TCP/IP module Advanced, LiBus** (order no. LRZ 935) with 8-pin RJ45 socket. Modbus allows established, efficient network communication as well as simple integration of LAUDA constant temperature equipment into existing automation systems.
- External **LiBus module box** (order no. LCZ 9727) with two additional module bays. The number of LiBus interfaces can be increased using the LiBus module box (LCZ 9727). Additional modules such as a solenoid valve for regulating the cooling water or a reverse flow protection can subsequently be connected.

4 Before starting up

4.1 Install device



DANGER!

Contact with voltage conductors due to faulty power supply cable

Electric shock

- Always use standard power supply cables such as the one supplied.
- Check the supplied power supply cable for damage prior to use.



DANGER!

The function of the overflow or drain is disrupted

Electric shock

- Overflow hose and drainage hose must each slope downward separately all the way into a collecting vessel.



WARNING!

Danger of the device rolling away or overturning

Impact, crushing

- Do not tilt the device!
- Position the device on an even, non-slip surface with a sufficient load carrying capacity!
- Actuate the caster brake when setting up the device!
- Do not place heavy parts on the device!



WARNING!

Distribution box / multiple socket is unsuitable

Fire

- Only connect the device directly to the socket on the installation side.
- Do not use distribution boxes or multiple sockets.



WARNING!

Danger of overpressure from high ambient temperature

Injury, escape of refrigerant, fire

- Observe the permitted ambient and storage temperatures.



WARNING!
Risk of heat transfer liquid escaping

Scalding, cold burns

- The temperature and media resistance of the hoses used for the device overflow must be suitable for the application.

Installation conditions:

- Irritant vapors may develop during operation of the device, depending on the heat transfer liquid used and working temperature. Always ensure that the vapors are adequately extracted.
- Note the electromagnetic compatibility (EMC) requirements of the device ↪ Chapter 1.3 “EMC requirements” on page 10.
- Do not cover the ventilation openings of the device.
- There is an overflow pipe on the rear of the device:
 - Extend the overflow pipe with piping or a hose.
 - The extension should end in a stable and heat-resistant vessel.
 - The connected extension should be as short as possible and must not reduce the diameter of the overflow pipe.
- Further installation conditions apply to the devices. These are specified in the technical data ↪ “Installation location” on page 158.

Personnel: ■ Operating personnel

1. Place the device on a suitable level surface.



The devices can be moved. To do this, release the parking brakes on the castors by pushing the lever upward.

2. Lock the castors of the device. To lock, press down the lever on the castor.

4.2 Hoses



WARNING! Escaping heat transfer liquid

Scalding, cold burns

- The temperature and media resistance of the hoses must be suitable for the application.
- Use hoses with a greater compressive strength than the maximum possible pump pressure. For liquids with a density above 1 kg/dm^3 , the pump pressure must be converted according to the density.
- Use pressure-resistant external applications or safety valves in the hydraulic circuit.
- When laying the hoses for the application, make sure that the hoses cannot be kinked or crushed.



WARNING! Contact with hot or cold hoses

Hot and cold burns

- Use insulated hoses for temperatures below $0 \text{ }^\circ\text{C}$ and above $70 \text{ }^\circ\text{C}$.

Please note:

- The thread connections of the pump connectors or the thread connections of the union nut and the seat of the nut must be moistened with lubricant.
- When laying the water cooling and heat transfer liquid hoses, make sure that the hoses cannot be kinked or crushed.

Approved metal hoses for Integral IN XT

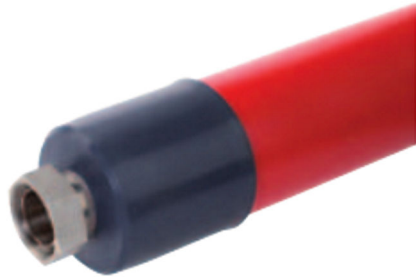

Metal hose made from stainless steel with union nuts

- Working pressure: maximum 10 bar
- Temperature range: -100 – 350 °C
- Application area: for heating and cooling applications with special insulation, for all LAUDA heat transfer liquids

Fig. 10: Corrugated metal hose with cold insulation

Hose type	Length in cm	Catalog number	Clear width in mm, connection thread	Maximum tightening torque in Nm
M30X 100S	100	LZM 091	DN20, M30 x 1.5	70
M30X 200S	200	LZM 092	DN20, M30 x 1.5	70
M30X 300S	300	LZM 093	DN20, M30 x 1.5	70
M38X 100S	100	LZM 094	DN25, M38 x 1.5	130
M38X 200S	200	LZM 095	DN25, M38 x 1.5	130
M38X 300S	300	LZM 096	DN25, M38 x 1.5	130

Approved elastomer hoses (for water cooled devices)

Hose made from EPDM with textile insert

- the EPDM hose is suitable for the cooling water supply
- Temperature range: -40 – 120 °C
- Application area: for all LAUDA heat transfer liquids, except Ultra 350, Kryo 65 and mineral oils

Hose type	Catalog number	Clear width, Ø in mm x wall thickness	Maximum working pressure in bar
EPDM hose with textile insert, not insulated	RKJ 103	½", Ø12 x 3.5	9
EPDM hose with textile insert, not insulated	RKJ 104	¾", Ø19 x 3.5	9
EPDM hose with textile insert, not insulated	RKJ 105	1", Ø25 x 3,5	6

4.3 Connecting an external application



WARNING!
Hot heat transfer liquid in the expansion vessel

Fire

- Applications with non-flow areas are not permitted. Otherwise, there is a risk of gas cushions forming during operation, which may force hot heat transfer liquid back into the expansion vessel.
Check this by reducing the pump power by one or two stages. The level indication of the device may not rise.
- Ventilate the installation site. Vapors which are hazardous to health may be produced.



WARNING!
Risk of hot heat transfer liquid overflowing

Fire

- A connecting hose with a collecting vessel must be attached to the overflow.
- The collecting vessel and connecting hose must be designed to withstand the maximum temperature of the heat transfer liquid.
- Avoid ignition sources in the vicinity of the collecting vessel.



WARNING!
Risk of heat transfer liquid escaping during operation due to open application

Scalding, cold burns

- Always use hydraulically sealed applications.



WARNING!

Bursting of the external application due to excessive pressure

Scalding, cold burns

- If the external application is located in a lower position and is sensitive to pressure, also take into account the additional pressure resulting from the difference in height between the application and the device.
- For pressure-sensitive applications (for example, glass apparatus) with a maximum permissible working pressure below the maximum pressure of the pump (see Technical data section), the hoses of the application must be laid in such a way that bending or squeezing is not possible.
- A separate safety valve must be installed in the outflow to protect against operating errors.
- The bypass is used to adjust the pump pressure according to your application.

Please note:

- Use the shortest possible hoses with the largest possible diameter in the external circuit.
If the diameter of the hose is too small, there will be a temperature gradient between the device and the external application due to the low flow rate. In this case, increase the outflow temperature or pump level accordingly.
- Secure the hoses to the hose nozzles using hose clips.
- Open any shut-off valves in the external application. Only switch on the device when flow is possible through the external application.
- Depending on the type of application, a vent valve can significantly simplify the aeration process. The vent valve must be located at the highest point of the circuit (Fig. 11).
- Reactors for steam heating are not suitable as external applications, as they usually have a non-flow-through area in which gas cushions can form.
- If the external control is used, a Pt100 sensor must be installed in the external application or the external temperature signal is transmitted via an interface module.
- If the external application is in a higher position, the application may run empty if the pump is switched off and air enters the thermostatic circuit (e.g. due to an incompletely closed or defective vent valve). This can cause the heat transfer liquid in the process thermostat to overflow.
- Install a dirt trap if the circuit in the application is not free of dirt.

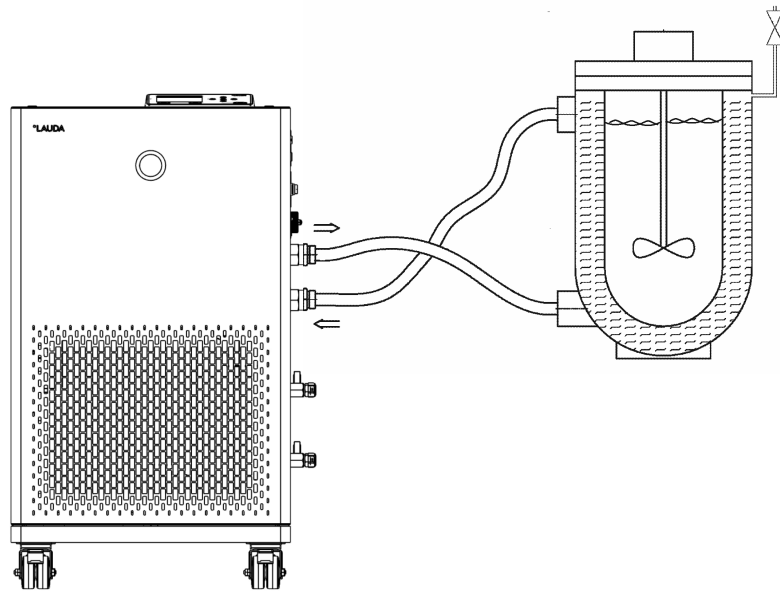

Fig. 11: Connection diagram with vent valve

The external application must be connected according to the sketch (Fig. 11) so that gas/vapor bubbles can be removed from the system and undisturbed operation is possible. The outflow of the pump must be connected to the lower connection of the application. The return line to the pump connector must be connected to the top connection of the application. The application is thus flowed through from bottom to top.

Mounting instructions for connecting an application

Hose nozzle:

- Push the hose onto the hose nozzle. Secure the hoses against slipping using hose clips or similar.

Ball bush and hose nozzle:

- The sealing surfaces of the cone and ball bush/hose nozzle may not be damaged (falling onto hard ground or similar).
- Carefully remove dirt from the sealing surfaces (cone and ball bush / hose nozzle) before assembly.
- Place the ball bush/hose nozzle vertically on the cone (support the hose when tightening).
- The ball bush / hose nozzle may not rotate when tightening the union nut (if necessary apply some grease or oil between the ball bush / hose nozzle and union nut).
- Tighten the union nut only moderately with the open-end wrench and hold it against the connecting sleeve with a second open-end wrench.

4.4 LAUDA heat transfer liquids



WARNING! Use of unsuitable heat transfer liquid

Fire, mutation, poisoning, environmental hazard, equipment damage

- Heat transfer liquids from LAUDA are recommended.
- If you wish to use your own heat transfer liquids, you must check that the fluids are suitable for the materials used. The heat transfer liquid must be provided with corrosion protection. You must also test the suitability of the liquid by performing a test run within the desired temperature range. During the test run, you must also check the low-level protection.
- Select a heat transfer liquid with a temperature range suitable for the application.
- Do not use any heat transfer liquid above the flash point in the expansion vessel.
- Do not use any heat transfer liquid more than 100 K below the ignition temperature.
- Do not use any heat transfer liquid that is radioactive, toxic or environmentally hazardous.
- Do not use ethanol or methanol because their flash point is below normal ambient temperature.
- Do not use deionized water as a heat transfer liquid.
- Only use heat transfer liquids that are approved for heat transfer systems.
- Use heat transfer liquids with a kinematic viscosity of less than 180 mm²/s during operation.
- Use heat transfer liquids with a density in the range of 0.75 to 1.8 g/cm³.
- Only use heat transfer liquids (glycol/water-based) with a freezing point below -52 °C.
- Only use heat transfer liquids (except glycol/water) with a freezing point below -70 °C.
- For cascades, only use heat transfer liquids with a freezing point below -100 °C.

Please note:

- If the heat transfer liquid reaches the lower limit of the temperature range, the temperature control properties can be expected to deteriorate as a result of the increase in viscosity. Therefore, only fully utilize this temperature range when absolutely necessary.
- Never use contaminated heat transfer liquid. Contamination in the pump housing can cause the pump to seize and the device to shut down.
- Observe the safety data sheets for the various heat transfer liquids. If required, you can download the safety data sheets from our homepage.
Open the LAUDA homepage, tap → *Services* → *Download center*.
In the Download center, chose the [Safety data sheet] option in the [Document type] drop-down list.
A list of safety data sheets in PDF format in different languages is displayed.
Tap the relevant safety data sheet.
The download starts and the PDF file is downloaded.

Please note:

- When using **Kryo 30**:
The water content decreases during longer periods of operation at higher temperatures and the mixture becomes combustible (flash point 119 °C). Check the mixing ratio using a hydrometer, for example.
- When using **Ultra 350** and **Kryo 65**:
EPDM hoses are not suitable for Ultra 350 and Kryo 65.
- When using **mineral oils**:
EPDM hoses are not suitable for mineral oils.
- When using **silicone oils**:
Silicone tubes are not suitable for silicone oils.

Table 5: Permissible heat transfer liquids for Integral IN XT (closed system)

Designation	Chemical characterization	Working temperature range in °C	Viscosity (kin) in mm ² /s at 20 °C	Viscosity (kin) in mm ² /s at temperature	Flash point in °C
Kryo 95	Silicone oil	-95 – 160	1.6	20 at -80 °C	64
Kryo 70 A	Silicone oil	-70 – 220	5.3	44 at -60 °C	125
Kryo 65	Hydrocarbon	-65 – 140	1.7	10 at -40 °C	62
Kryo 30	Water/monoethylene glycol mixture	-30 – 90	4	50 at -25 °C	---
Ultra 350	Aromatic hydrocarbon	30 – 350	48	16 at 40 °C	212
Ultra 301	Mineral oil	40 – 300	76.5	35.4 at 40 °C	245



Water may NOT be used with any Integral IT XT units over the entire working temperature range.

Table 6: Heat transfer liquid catalog numbers

Designation	Container size			
	Catalog number			
	5 L	10 L	20 L	200 L
Kryo 95	LZB 130	LZB 230	LZB 330	---
Kryo 70 A	LZB 131	LZB 231	LZB 331	---
Kryo 65	LZB 118	LZB 218	LZB 318	---
Kryo 51	LZB 121	LZB 221	LZB 321	---
Kryo 30	LZB 109	LZB 209	LZB 309	LZB 809
Ultra 350	LZB 107	---	---	---
Ultra 301	LZB 153	LZB 253	LZB 353	---

4.5 Cooling water requirements

This section is relevant for:

- Water-cooled devices

Requirements

Cooling water is subject to specific purity requirements. A suitable procedure must be employed to purify the cooling water in line with the contamination in the water and maintain the water quality. Unsuitable cooling water may cause the condenser and the entire cooling water circuit to become blocked or damaged, or start to leak. The entire cooling circuit and cooling water circuit may sustain extensive consequential damage as a result.

- Free chlorine consisting of disinfectant, for example, and water containing chloride will cause pitting corrosion in the cooling water circuit.
- Distilled, deionized and demineralized water are unsuitable due to their reactivity and will cause corrosion in the cooling water circuit.
- Sea water is unsuitable due to its corrosive properties and will cause corrosion in the cooling water circuit.
- Iron particles and water containing iron will cause corrosion in the cooling water circuit.
- Hard water is unsuitable for cooling due to the high lime content and will lead to calcification of the cooling water circuit.
- Cooling water containing suspended matter is unsuitable.
- Untreated, unpurified water such as river water or cooling tower water is unsuitable due to its microbiological content (bacteria), which can settle inside the cooling water circuit.

Suitable cooling water quality

Data	Value	Unit
pH value	7.5 – 9.0	---
Hydrocarbonate [HCO_3^-]	70 – 300	mg/L

Data	Value	Unit
Chloride	< 50	mg/L
Sulfate [SO ₄ ²⁻]	< 70	mg/L
Ratio hydrogen carbonate [HCO ₃ ⁻] / sulfate [SO ₄ ²⁻]	> 1	---
Total water hardness	4.0 – 8.5	°dH
Electrical conductivity	30 – 500	µS/cm
Sulfite (SO ₃ ²⁻)	< 1	mg/L
Free chlorine gas (Cl ₂)	< 0.5	mg/L
Nitrate (NO ₃ ⁻)	< 100	mg/L
Ammonia (NH ₃)	Not permitted	---
Iron (Fe), dissolved	< 0.2	mg/L
Manganese (Mn), dissolved	< 0.05	mg/L
Aluminum (Al), dissolved	< 0.2	mg/L
Free aggressive carbon dioxide (CO ₂)	Not permitted	---
Hydrogen sulfide (H ₂ S)	Not permitted	---
Algae growth	Not permitted	---
Suspended matter	Not permitted	---

4.6 Connecting the cooling water

This section is relevant for:

- Water-cooled devices

! **NOTICE!**
Cooling water circuit leaking due to corrosion

Device damage
<ul style="list-style-type: none"> ● Do not use corrosive cooling water.

All water-cooled devices are equipped with the following cooling water connection:

- Exterior thread (male) G ¾ inch

Table 7: Cooling water data

Specification	Value
Maximum cooling water pressure, see the chapter "Technical data"	10 bar
Cooling water temperature, see the chapter "Technical data"	15°C recommended; 10 to 30°C permitted (in upper temperature range with reduced cooling output)
Cooling water pressure difference	3 bar recommended; 0.8 to 5 (10) bar permitted (in lower temperature range with reduced cooling output)

Settings in the cooling water circuit menu

In the cooling water circuit menu, you have the choice of selecting either the [Cooling water circuit] (factory setting) or the [Mains water tap water] setting.

Selecting the [Mains water tap water] setting reduces the water consumption during regular operation. As a result, the outlet temperature of the cooling water is significantly higher due to the lower water throughput. This setting is not recommended for cooling water circuits.

Please note:

- Connect the cooling water inlet and outlet according to the labeling on the device. The inlet and outlet of the cooling water supply may not be interchanged.
- The hoses used for the cooling water circuit must be suitable for the temperature range specified. Also observe the permitted hose diameter.
- Secure the hose nozzles or the coupling connectors to the hoses using hose clips.
- Secure the water cooling return hose in the outlet area to prevent the hose from jerking suddenly, even when pressure surges occur. Secure the water cooling return hose in the outlet area in such a way that hot cooling water cannot spray out.
- Avoid kinking or crushing the hoses.
- We recommend using a leakage water detector with water shut-off function to prevent leakages from causing damage in the cooling water system.
- Only use cooling water that meets the quality requirements.
- If the condenser leaks, there is a danger that refrigerating machine oil or refrigerant from the device's refrigerant circuit will mix with the cooling water. Observe the legal requirements and provisions of the water supply company applicable at the operation site.

4.7 Configuring interfaces



DANGER!
Contact with live parts during installation

Electric shock

- Disconnect the device before installing modules.
- Only skilled personnel are permitted to install/replace interface modules.

4.7.1 Potential-free contact (alarm output)

Configuration

In the *Alarm output* menu, an option is always selected. The selected option is marked with a check mark. You can combine the other options.

A fault in the device can be an alarm or an error.

Table 8: Possible options

Options	Signal output	Description
<i>Fault</i>	Signal: Fault	A signal is issued at the alarm output (e.g. for reverse flow protection, pilot lamp)
<i>Safe Mode</i>	Signal: Safe Mode	Device activates Safe Mode (you must first enable Safe Mode in the device menu)
<i>Standby</i>	Signal: Standby	Device switches to standby

Personnel: Operating personnel

1. Switch to the main menu.
2. Select the *Settings* → *Basic setting* → *Alarm output* menu item.
3. The following options are available:
 - *Fault*
 - *Safe Mode*
 - *Standby*
4. Press the Enter key to confirm your selection.

Contact assignment and function description

- The contacts may be loaded with a maximum voltage of 30 V direct current (DC) and a maximum current of 0.2 A.

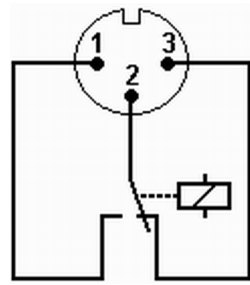

Fig. 12: Flange plug (front) in fault condition

View of the flange plug (front) or into the coupling socket on the soldering side.

Good condition

- Pin 1 and 2 are closed.
- During trouble-free operation, the alarm output is in good state.

Fault condition

- Pin 2 and 3 are closed.
- The alarm output is in fault condition:
 - If the device is switched off,
 - after switching on, if a fault (e.g. low level) is already present,
 - during operation, if a fault occurs, and
 - for each event configured in the *Alarm Output* menu.

Please note the following:

- The equipment connected to the extra-low voltage inputs and outputs must be reliably isolated from voltages dangerous to the touch in accordance with DIN EN 61140. For example, by double or reinforced insulation according to DIN EN 60730-1 or DIN 60950-1.
- Only use protected connection lines. Connect the protective screen with the connector shell. Cover unused connectors with protective caps.

4.7.2 Configuring the Ethernet interface

Technical data of the Ethernet interface

Data	Value	Unit
Ethernet - standard	10/100	MBit

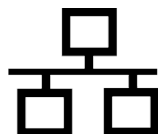

PC control

- The *PC control* menu item enables the device to be accessed by a PC or control station. Activate this function if you wish to control or monitor the constant temperature equipment from an external control station.

Before the constant temperature equipment and control station can be operated together in a local network (LAN), the Ethernet interface must be configured.

The Ethernet interface can be configured in two different ways:

- | | |
|--|---|
| Automatically obtain LAN configuration | - In order for this to work, a DHCP server must be present in the local network (LAN). If communication is direct, the control station must support the auto IP procedure. |
| Manually configure LAN configuration | - Manual configuration must be performed if a DHCP server is not available, the auto IP procedure is not supported or you want to use the Ethernet interface with fixed IP addresses. |

Obtain LAN configuration automatically (DHCP client on)

Personnel: Specialized personnel

1. Switch on the constant temperature equipment.
2. Press the [Enter key] to open the menu.
3. Use the cursor keys to select the menu items → *Setup* → *Basic setup* → *Ethernet* → *LAN settings* → *DHCP client*.
 - ▶ The options [off] and [on] appear on the display.
4. Select the option [On] and press [OK] to confirm.
 - ▶ A check mark is set. The DHCP client is active. The Ethernet interface is configured automatically.
5. In the [PC control] menu, select the [on] entry.
 - ▶ A check mark is set. The control for the control station is activated.
6. If required, enter the port number in the [PC control] menu.

Specify LAN configuration manually (DHCP client off)

1. Switch on the constant temperature equipment.
2. Press the [Enter key] to open the menu.
3. Select the menu items → *Setup* → *Basic setup* → *Ethernet* → *LAN configuration* → *DHCP client*.
 - ▶ The options [off] and [on] appear on the display.
4. Select the [Off] option and press the Enter key to confirm.
 - ▶ A check mark is set. The entry has been accepted.
5. Use the left arrow key to go back one menu level.
6. Scroll to the numerical values of the [Local IP address] menu item and press the Enter key.
 - ▶ The *Local IP address* menu opens.
7. Byte 1 is marked. Press the right arrow key.
 - ▶ The Input window opens. The area for entering the numerical values is displayed.

8. Enter the numerical value for byte 1. Confirm the value with the Enter key [OK].



The numerical values are entered byte by byte. From top to bottom, from byte 1 to byte 4, for example 120.0.0.13 (byte1.byte2.byte3.byte4).

Press [ESC] to cancel the entry.

9. Enter the numerical values for byte 2, byte 3 and byte 4.
10. Once you have entered the numerical values, press the left arrow key.
 - ▶ You return to the *LAN configuration* menu.
11. Scroll to the numerical values of the [Local mask] menu item and press the Enter key.
 - ▶ The *Local mask* menu opens.
12. Enter the numerical values, as described in points 7 to 9.
13. Once you have entered the numerical values, press the left arrow key.
 - ▶ You return to the *LAN configuration* menu.
14. If required, also enter the numerical values for the [Gateway] and [DNS server].
15. Once you have entered the numerical values, press the left arrow key.
 - ▶ The entered numerical values of [Local IP address], [Local mask], [Gateway] and [DNS server] are displayed.
16. Press the [ANW.] softkey to accept the entered numerical values.
17. Press the left cursor key to move up one menu level and select the *PC control* menu item and press Enter.
18. Confirm the [PC control] entry once more.
19. Select the option [on] and confirm the entry.
 - ▶ The control for the control station is activated.



*No settings are accepted if you leave the *LAN configuration* menu without first pressing the [ANW.] key.*



Set the [DHCP client] from [off] to [on], all numerical values are reset to 0. 0. 0. 0.



If you have set up Ethernet communication between the control station and the constant temperature equipment, it may take 1 or 2 minutes to establish the connection.

Checking the LAN network

1. Start the Windows command processor by entering `cmd.exe` on the PC with Microsoft Windows operating system.
 - ▶ The entry window will open.
2. There are two ways of checking:
 - Enter the ping command together with the IP address.
`ping xxx.xxx.xxx.xxx`
For "XXX.XXX.XXX.XXX", put the IP address that was entered when the Ethernet interface was configured.
 - Or
 - Enter the ping command together with the serial number of the thermostatic circulator (possible with software control system 1.36 or later).
`ping serial number`
 - ▶ If the Ethernet interface is configured and connected correctly, the interface will return four responses within a very short time. See Fig. 13.

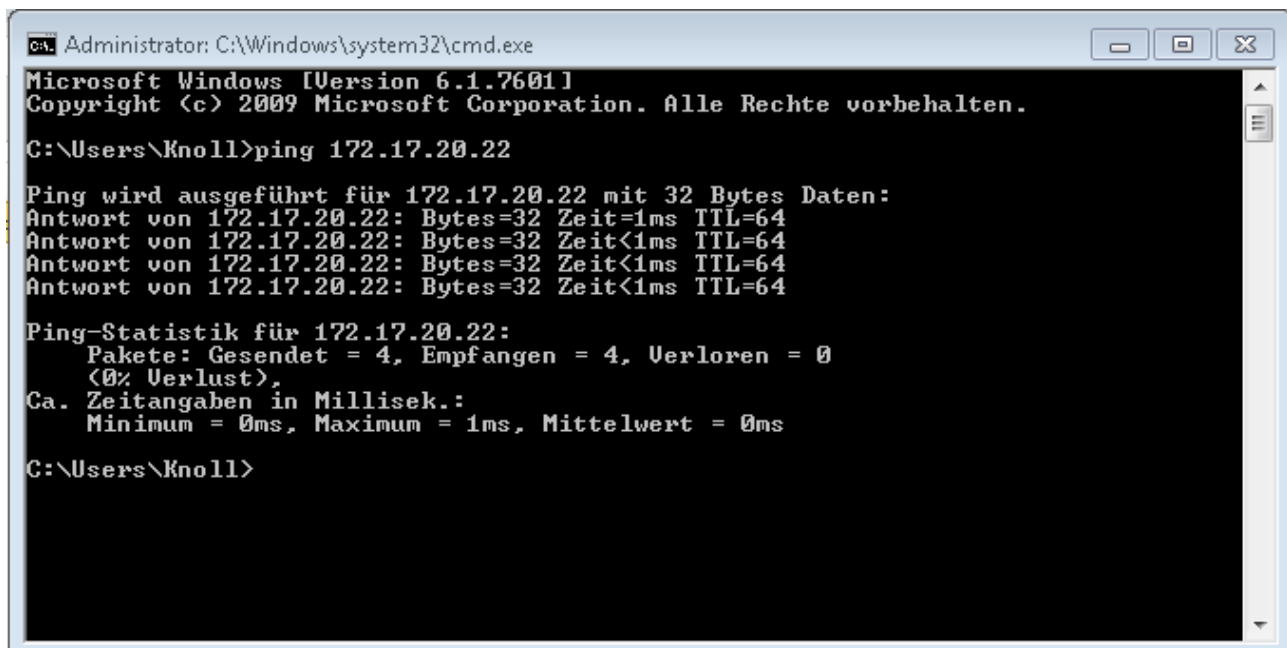

```
Administrator: C:\Windows\system32\cmd.exe
Microsoft Windows [Version 6.1.7601]
Copyright (c) 2009 Microsoft Corporation. Alle Rechte vorbehalten.
C:\Users\Knoll>ping 172.17.20.22

Ping wird ausgeführt für 172.17.20.22 mit 32 Bytes Daten:
Antwort von 172.17.20.22: Bytes=32 Zeit=1ms TTL=64
Antwort von 172.17.20.22: Bytes=32 Zeit<1ms TTL=64
Antwort von 172.17.20.22: Bytes=32 Zeit<1ms TTL=64
Antwort von 172.17.20.22: Bytes=32 Zeit<1ms TTL=64

Ping-Statistik für 172.17.20.22:
    Pakete: Gesendet = 4, Empfangen = 4, Verloren = 0
    (0% Verlust),
    Ca. Zeitangaben in Millisek.:
    Minimum = 0ms, Maximum = 1ms, Mittelwert = 0ms
C:\Users\Knoll>
```

Fig. 13: Example for entering the ping command

Check the LAN network and the process interface

It is easy to check the connection to the interface with a PC and Microsoft Windows operating system.

- For operating systems Windows Vista, Windows 7, Windows 8, Windows 10, and Windows 11 "HyperTerminal"* is not part of the operating system.



*Terminal programs are available on the Internet as freeware. These programs offer features similar to "HyperTerminal" (for example PuTTY or RealTerm). Search query "serial port terminal program".

Checking with RealTerm

1. Open the program "HyperTerminal" or the "terminal program" on a PC with Microsoft Windows operating system.
 - ▶ The Input window opens.

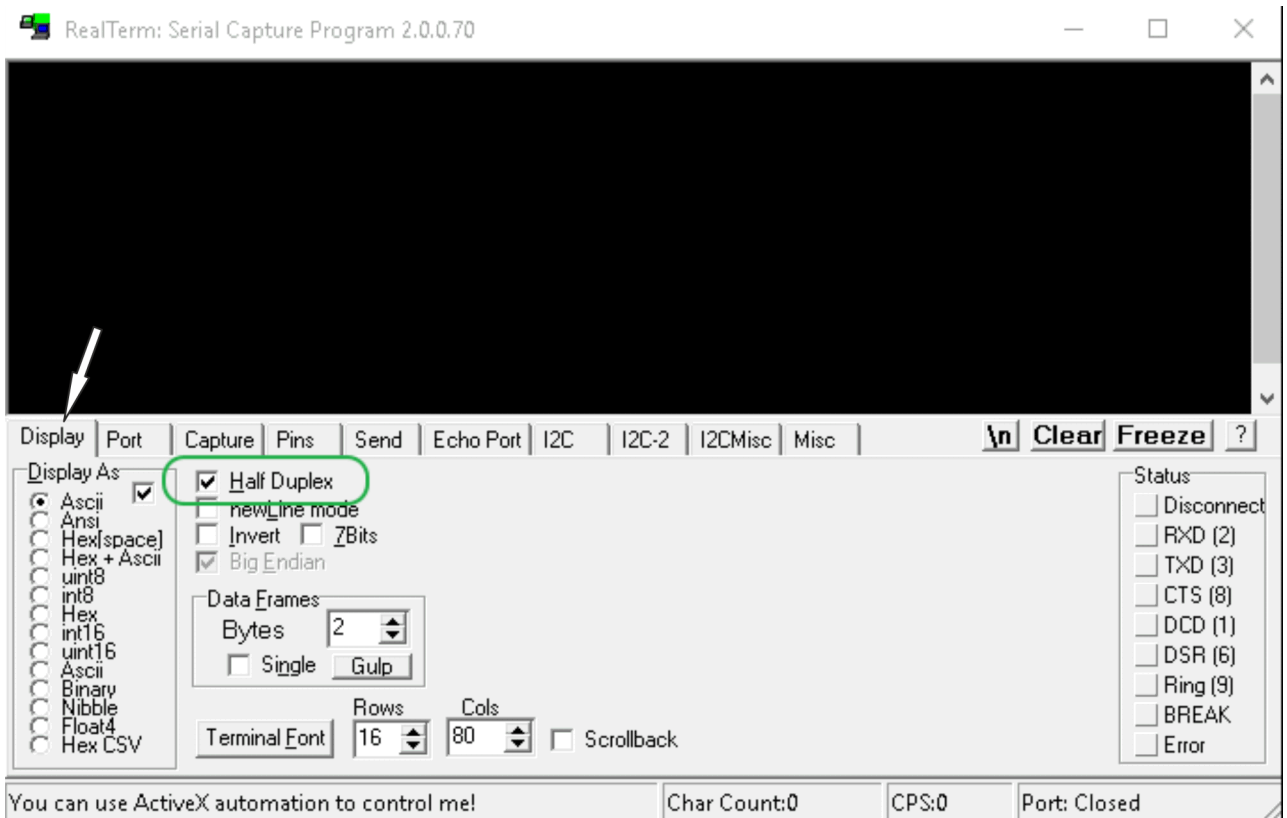

Fig. 14: "RealTerm" program

2. Place a checkmark under *Half Duplex* in the *Display* tab.

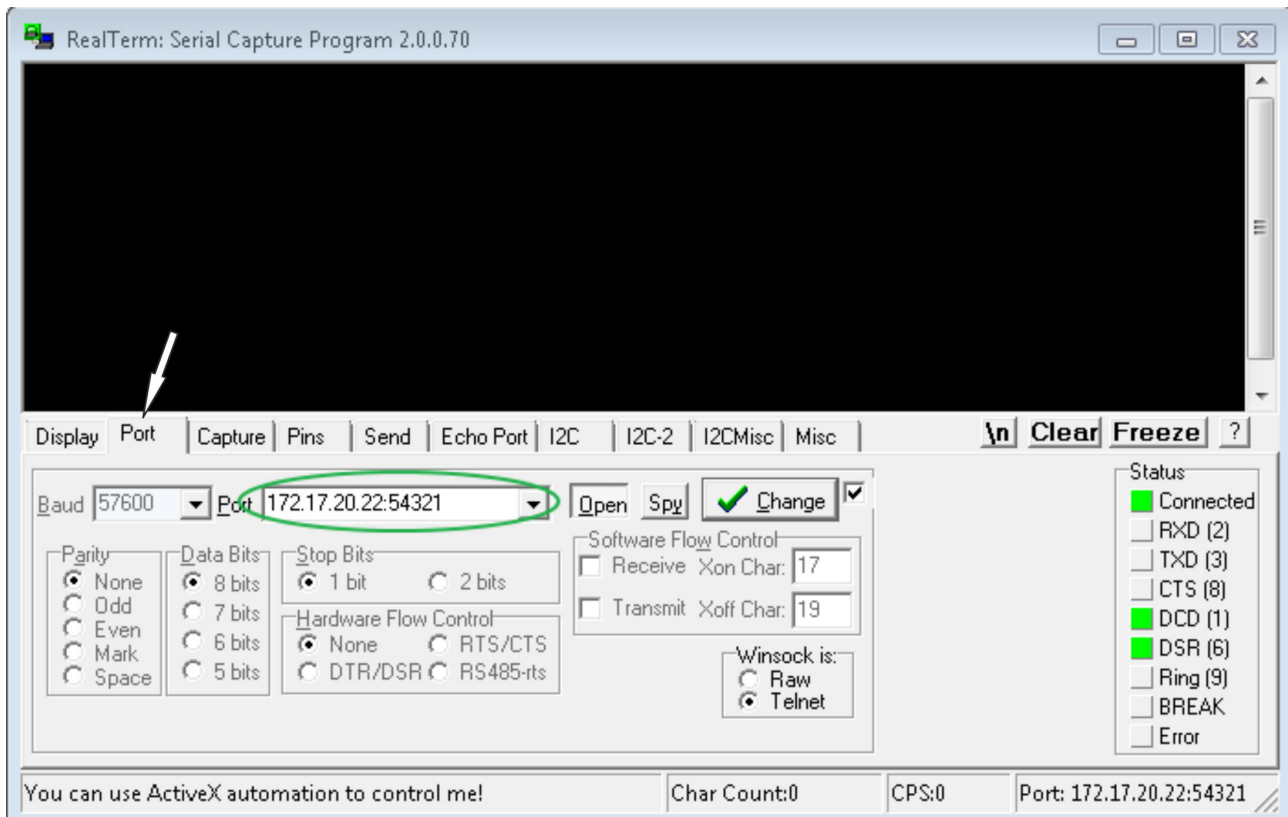

Fig. 15: Entry in the Port field

3. Enter the configured IP address and port number of the Ethernet interface on the constant temperature equipment in the *Port* tab. When you are doing this, be sure that the IP address and port number are separated by a colon.
You can enter the serial number of the constant temperature equipment instead of the IP address.
4. Then press the [Open] button.
5. Open the *Send* tab.
 - ▶ Now that the program has been configured, the actual test can begin.
6. Place a checkmark under *+CR* and *+LF*.

4.7.4 Protocol of the interface

Note the following instructions:

- The command from the computer must be made with a CR, CRLF, or LFCR.
- The response from the thermostatic circulator is always made with a CRLF.
- After each command sent to the thermostat, it is necessary to wait for the reply before sending another command. This ensures that the sequencing of inquiries and answers is clear.

CR = Carriage Return (Hex: 0D); LF = Line Feed (Hex: 0A)

Table 9: Example with set point transfer of 30.5 °C to the thermostatic circulator

Computer	Temperature control device
"OUT_SP_00_30.5"CRLF	➔
➔	"OK"CRLF

4.7.5 Read commands

The interface module recognizes the following read commands, which you can use to retrieve operating data of the constant temperature equipment.

Table 10: Temperature

ID	Function	Unit, resolution	Command
2	Temperature set point	[°C]	IN_SP_00
3	Bath temperature (outflow temperature)	[°C], 0.01°C	IN_PV_00
4	Bath temperature (outflow temperature)	[°C], 0.001°C	IN_PV_10
5	Controlled temperature (internal/external Pt/external analog/external serial)	[°C]	IN_PV_01
7	External temperature T_E (Pt)	[°C]	IN_PV_03
8	External temperature T_E (analog input)	[°C]	IN_PV_04
14	External temperature T_E (Pt)	[°C], 0.001°C	IN_PV_13
25	Overtemperature turn off point T_{Max}	[°C]	IN_SP_03
27	Limitation of outflow temperature T_{iH} (upper limit)	[°C]	IN_SP_04
29	Limitation of outflow temperature T_{iH} (lower limit)	[°C]	IN_SP_05
33	Set temperature T_{set} in Safe Mode (Safe set point in event of interruption in communication).	[°C]	IN_SP_07
158	Actuating signal of master controller in case of external control	[°C]	IN_PV_11

ID	Function	Unit, resolution	Command
162	Overtemperature turn off point, tank (only for Integral IN XT)	[°C]	IN_SP_12
163	Overtemperature turn off point, outlet (only for Integral IN P)	[°C]	IN_SP_13

Table 11: Pump

ID	Function	Unit	Command
6	Outflow pressure / pump pressure, relative to the atmosphere	[bar]	IN_PV_02
12	Through-flow of the pump (Flow controller must be connected)	[l/min]	IN_PV_07
18	Pump power stage (only applies to Integral IN XT/P and PRO)	[-]	IN_SP_01
31	Outflow pressure / pump pressure set point (only applies to Integral IN XT/P with pressure control settings)	[bar]	IN_SP_06
37	Through-flow control set point (Flow controller must be connected)	[l/min]	IN_SP_09
71	Status of through-flow control: 0 = Off / 1 = On	[-]	IN_MODE_05
154	Outflow pressure of flow controller, relative to the atmosphere (Flow controller must be connected)	[bar]	IN_PV_09
156	Pressure limitation set point with active through-flow control (Flow controller must be connected)	[bar]	IN_SP_10
157	Overpressure turn off point with active through-flow control (Flow controller must be connected)	[bar]	IN_SP_11
160	Valve position of the flow controller (Flow controller must be connected)	[%]	IN_PV_12

Table 12: Fill level

ID	Function	Unit	Command
9	Heat transfer liquid level (fill level)	[-]	IN_PV_05

Table 13: Actuating signal

ID	Function	Unit, resolution	Command
11	Resolution of controller actuating signal in per mill – negative value → device is cooling – positive value → device is heating	[%]	IN_PV_06
13	Controller actuating signal in watts – negative value → device is cooling – positive value → device is heating	[W]	IN_PV_08

Table 14: Cooling

ID	Function	Unit	Command
24	Cooling mode: 0 = Off / 1 = On / 2 = Automatic	[-]	IN_SP_02

Table 15: Safety

ID	Function	Unit	Command
35	Timeout communication via interface (1 - 99 seconds; 0 = Off)	[s]	IN_SP_08
73	Status of Safe Mode: 0 = Off (inactive) / 1 = On (active)	[-]	IN_MODE_06
202	Status of exclusive operator privileges for the interface (1 = Active/ 0 = Inactive)	[-]	IN_MODE_09

Table 16: Control parameters

ID	Function	Unit	Command
39	Control parameter Xp	[-]	IN_PAR_00
41	Control parameter Tn (181 = Off)	[s]	IN_PAR_01
43	Control parameter Tv	[s]	IN_PAR_02
45	Control parameter Td	[s]	IN_PAR_03
47	Control parameter KpE	[-]	IN_PAR_04
49	Control parameter TnE	[s]	IN_PAR_05
51	Control parameter TvE	[s]	IN_PAR_06
53	Control parameter TdE	[s]	IN_PAR_07
55	Correction limitation	[K]	IN_PAR_09
57	Control parameter XpF	[-]	IN_PAR_10
61	Control parameter Prop_E	[K]	IN_PAR_15

Table 17: Control

ID	Function	Unit	Command
59	Setpoint offset	[K]	IN_PAR_14
67	Control in control variable X: 0 = internal / 1 = external Pt / 2 = external analog / 3 = external serial / 5 = external Ethernet / 6 = external EtherCAT / 7 = external Pt 2 (only on Integral) / 8 = ext. Comm. Mod.	[-]	IN_MODE_01
69	Offset source X for set point: 0 = normal / 1 = external Pt / 2 = external analog / 3 = external serial / 5 = external Ethernet / 6 = external EtherCAT / 7 = external Pt 2 (only on Integral) / 8 = ext. Comm. Mod.	[-]	IN_MODE_04

Table 18: Rights

ID	Function	Unit	Command
63	Status of Master keyboard: 0 = free / 1 = blocked	[-]	IN_MODE_00
65	Status of remote control keyboard: 0 = free / 1 = blocked Remote control must be connected	[-]	IN_MODE_03

Table 19: Status

ID	Function	Unit	Command
75	Status of standby: 0 = device is on / 1 = device is off	[-]	IN_MODE_02
107	Device type (e.g.: "INT" or "INXT")	[-]	TYPE
130	Device status: 0 = OK / -1 = fault	[-]	STATUS
131	Fault diagnosis; a 7-digit answer in the format XXXXXXX is output, whereby each digit X contains fault information (0 = no fault / 1 = fault). The following information is defined for the seven places of the answer format: <ul style="list-style-type: none"> ■ First digit = error ■ Second digit = alarm ■ Third digit = warning ■ Fourth digit = overtemperature ■ Fifth digit = low level ■ Sixth digit = 0 (alarm setting: high level) ■ Seventh digit = external control value missing 	[-]	STAT
161	Serial number, alphanumerical (10 characters)	[-]	SERIAL_NO

Table 20: Programmer

ID	Function	Unit	Command
77	Program used as a basis for further commands	[-]	RMP_IN_04
85	Programmer segment	[-]	RMP_IN_00_[seg . no.]
88	Current segment number	[-]	RMP_IN_01
90	Number of preset program sequences	[-]	RMP_IN_02
92	Current program loop	[-]	RMP_IN_03
94	Currently running program (0 = no program currently running)	[-]	RMP_IN_05

Table 21: Contact input / output

ID	Function	Unit	Command
96	Contact input 1: 0 = open / 1 = closed	[-]	IN_DI_01
98	Contact input 2: 0 = open / 1 = closed	[-]	IN_DI_02
100	Contact input 3: 0 = open / 1 = closed	[-]	IN_DI_03
102	Contact output 1: 0 = open / 1 = closed	[-]	IN_DO_01
104	Contact output 2: 0 = open / 1 = closed	[-]	IN_DO_02
106	Contact output 3: 0 = open / 1 = closed	[-]	IN_DO_03

Table 22: SW version

ID	Function	Unit	Command
108	Control system	[-]	VERSION_R
109	Protection system	[-]	VERSION_S
110	Remote control (Command) (remote control unit must be present)	[-]	VERSION_B
111	Cooling system (only for devices with active cooling)	[-]	VERSION_T
112	Analog interface module (interface module must be present)	[-]	VERSION_A
113	Flow controller (flow controller must be present)	[-]	VERSION_A_1
114	RS 232/485 interface module or Profibus/Profinet/CAN (interface module must be present)	[-]	VERSION_V
116	EtherCAT interface module (interface module must be present)	[-]	VERSION_Z
117	Contact interface module (interface module must be present)	[-]	VERSION_D
118	Solenoid valve for cooling water (solenoid valve must be fitted) (only applies to Integral IN T)	[-]	VERSION_M_0
124	Pump 0 (applies to Integral IN XT/P)	[-]	VERSION_P_0
125	Pump 1 (applies to Integral IN XT/P, but only to devices with a double pump or supplementary pump)	[-]	VERSION_P_1
126	Heating system 0	[-]	VERSION_H_0
127	Heating system 1 (only applies to devices with a heater > 16 kW)	[-]	VERSION_H_1

ID	Function	Unit	Command
128	External Pt interface 0 (an external temperature module must be present)	[-]	VERSION_E
129	External Pt interface 1 (a second external temperature module must be present)	[-]	VERSION_E_1

Table 23: Pressure overlay

ID	Function (only applies to devices with pressure overlay)	Unit	Command
165	Set pressure for pressure overlay (applies to Integral IN P)	[bar]	IN_SP_14
166	Tank pressure of pressure overlay (applies to Integral IN P)	[bar]	IN_PV_14
168	Pressure overlay hysteresis (applies to Integral IN P)	[bar]	IN_SP_15

Table 24: Filling system

ID	Function	Unit	Command
169	Status of the filling and draining unit (0 = Init., 1 = Standby, 2 = Pre-temp. ctrl., 3 = Drain, 4 = Change application, 5 = Leak test, 6 = Fill, 7 = Pause, 8 = Refill, 9 = Decommission) Caution! Filling and draining unit must be connected.	[-]	IN_MODE_07
172	Draining temperature	[°C]	IN_SP_16
174	Pressure specification for leak test	[bar]	IN_SP_17
176	Leak test duration	[s]	IN_PAR_16
178	Maximum permissible pressure difference during leak test	[bar]	IN_PAR_17
180	Venting time at the end of the filling process	[s]	IN_PAR_18
182	Target filling level of the expansion tank of the constant temperature equipment during the filling process	[-]	IN_SP_18
184	Status of automatic filling device for the filling and draining unit tank (0 = off, 1 = on)	[-]	IN_MODE_08
186	Start of automatic filling device (lower fill limit -> refilling on)	[%]	IN_PAR_19
188	Stop of automatic filling device (upper fill limit -> refilling off)	[%]	IN_PAR_20
189	Filling/draining system outflow pressure	[bar]	IN_PV_15
190	Filling/draining system tank level	[%]	IN_PV_16
Not with Integral IN T			

4.7.6 Write commands

The control station (PC, PLC, etc.) obtains (basic) operator privileges when sending a write command. This only works if the control station has not been locked by another control element. If the control station is locked, error message ERR_38 is issued. ↪ Chapter 6.21 “Operator and viewer” on page 119



Addition to timeout and operator privileges:

No exclusive operator privileges are set when setting the timeout (ID 34 + 35). If necessary, exclusive operator privileges must be set manually using a command (ID 201 + 202). However, the timeout (timeout ≠ 0) must be actively functioning to switch on exclusive operator privileges. This ensures that the constant temperature equipment retains its operator privileges if the connection is interrupted.



The constant temperature equipment confirms each write command with OK, e.g. the reply from the device address A015 is "A015_OK". In the event of an error, an error message is output as a reply, e.g. "A015_ERR_6". ↪ Chapter 4.7.7 “Error messages” on page 57

The interface module recognizes the following write commands, which you can use to transfer values to the constant temperature equipment.

Table 25: Temperature

ID	Function	Unit	Command
1	Temperature set point	[°C]	OUT_SP_00_XXX.XX
15	Actual value of external temperature (via interface)	[°C]	OUT_PV_05_XXX.XX
26	Limitation of outflow temperature TiH (upper limit)	[°C]	OUT_SP_04_XXX.XX
28	Limitation of outflow temperature TiH (lower limit)	[°C]	OUT_SP_05_XXX.XX
32	Temperature set point T_{set} in Safe Mode	[°C]	OUT_SP_07_XXX.XX

Table 26: Pump

ID	Function	Unit	Command
17	Pump power stage 1 – 8	[–]	OUT_SP_01_XXX
30	Set point pressure (with pressure control settings, applies to Integral IN XT/P)	[bar]	OUT_SP_06_X.XX
36	Through-flow control set point (Flow controller must be connected)	[l/min]	OUT_SP_09_X.XX
70	Activate through-flow control: 0 = switch off / 1 = switch on	[–]	OUT_MODE_05_X

ID	Function	Unit	Command
155	Pressure limitation set point with active through-flow control (Flow controller must be connected and equipped with an integrated pressure sensor)	[bar]	OUT_SP_10_X.X
159	Actual value of external pressure control variable (via interface)	[bar]	OUT_PV_06_XX.XX

Table 27: Cooling

ID	Function	Unit	Command
23	Cooling mode: 0 = Off / 1 = On / 2 = Automatic	[-]	OUT_SP_02_XXX

Table 28: Safety

ID	Function	Unit	Command
34	Timeout communication via interface (1 – 99 seconds; 0 = Off)	[s]	OUT_SP_08_XXX
72	Activate Safe Mode	[-]	OUT_MODE_06_1
201	Activate/deactivate exclusive operator privileges for interface 1 = obtain exclusive privileges. 0 = Relinquish exclusive privileges	[-]	OUT_MODE_09_XXX

Table 29: Control parameters

ID	Function	Unit	Command
38	Control parameter Xp	[-]	OUT_PAR_00_XX.X
40	Control parameter Tn (5 – 180 s; 181 = Off)	[s]	OUT_PAR_01_XXX
42	Control parameter Tv	[s]	OUT_PAR_02_XXX
44	Control parameter Td	[s]	OUT_PAR_03_XX.X
46	Control parameter KpE	[-]	OUT_PAR_04_XX.XX
48	Control parameter TnE (0 – 9000 s; 9001 = Off)	[s]	OUT_PAR_05_XXXX
50	Control parameter TvE (5 = Off)	[s]	OUT_PAR_06_XXXX
52	Control parameter TdE	[s]	OUT_PAR_07_XXXX.X
54	Correction limitation	[K]	OUT_PAR_09_XXX.X
56	Control parameter XpF	[-]	OUT_PAR_10_XX.X
60	Control parameter Prop_E	[K]	OUT_PAR_15_XXX

Table 30: Control

ID	Function	Unit	Command
58	Setpoint offset	[K]	OUT_PAR_14_XXX.X
66	Control in control variable X: 0 = internal / 1 = external Pt / 2 = external analog / 3 = external serial / 5 = external Ethernet / 6 = external EtherCAT / 7 = external Pt 2 (only on Integral) / 8 = ext. Comm. Mod.	[-]	OUT_MODE_01_X
68	Offset source X for set point: 0 = normal / 1 = external Pt / 2 = external analog / 3 = external serial / 5 = external Ethernet / 6 = external EtherCAT / 7 = external Pt 2 / 8 = ext. Comm. Mod.	[-]	OUT_MODE_04_X

Comment (ID 66 and 68): If X=3, the commands ID 66 and ID 68 cannot be executed in some constant temperature equipment until an external temperature specification has been received (via the command ID 15).

Table 31: Rights

ID	Function	Unit	Command
62	Master keyboard (equivalent to "KEY"): 0 = unlock / 1 = lock	[-]	OUT_MODE_00_X
64	Keyboard remote control unit (command): 0 = unlock / 1 = lock	[-]	OUT_MODE_03_X

Table 32: Status

ID	Function	Unit	Command
74	Switch the device on / off (standby)	[-]	START / STOP

Table 33: Programmer

ID	Function	Unit	Command
76	Select the program for the subsequent commands (X = 1 – 5). The default program is 5 when the constant temperature equipment is switched on. Caution! Executing this command may stop any programs that are currently running.	[-]	RMP_SELECT_X
78	Start programmer	[-]	RMP_START
79	Pause programmer	[-]	RMP_PAUSE
80	Continue programmer (after pause)	[-]	RMP_CONT
81	End programmer	[-]	RMP_STOP
83	Delete program (all segments)	[-]	RMP_RESET

ID	Function	Unit	Command
84	Programmer segment	[-]	RMP_OUT_00_[Temp.]_[Time]_[Tol]_[Pumpstep]
89	Number of preset program sequences XXX = 1 - 250; 0 = endless	[-]	RMP_OUT_02_XXX

Table 34: Pressure overlay

ID	Function (only applies to devices with pressure overlay)	Unit	Command
164	Set pressure for pressure overlay (applies to Integral IN P)	[bar]	OUT_SP_14_XXX
167	Pressure overlay hysteresis (applies to Integral IN P)	[bar]	OUT_SP_15_XXX

Table 35: Filling system

ID	Function	Unit	Command
170	Action at the filling and draining unit (0 = No action, 1 = Start draining, 2 = Start filling) Caution! Filling and draining unit must be connected.	[-]	OUT_MODE_07_[value]
171	Draining temperature	[°C]	OUT_SP_16_[value]
173	Pressure specification for leak test	[-]	OUT_SP_17_[value]
175	Leak test duration	[-]	OUT_PAR_16_[value]
177	Maximum permissible pressure difference during leak test	[-]	OUT_PAR_17_[value]
179	Venting time at the end of the filling process	[-]	OUT_PAR_18_[value]
181	Target filling level of the expansion tank of the constant temperature equipment during the filling process	[-]	OUT_SP_18_[value]
183	Status of automatic filling device for the filling and draining unit tank (0 = off, 1 = on)	[-]	OUT_MODE_08_[value]
185	Start of automatic filling device (lower fill limit -> refilling on)	[%]	OUT_PAR_19_[value]
187	Stop of automatic filling device (upper fill limit -> refilling off)	[%]	OUT_PAR_20_[value]
Not with Integral IN T			

4.7.7 Error messages

The error messages of the Ethernet interface are described in the following. The string *ERR_X* or *ERR_XX* is output after an incorrect command.

Error	Description
ERR_2	Incorrect entry (for example, buffer overflow)
ERR_3	Wrong command
ERR_5	Syntax error in value
ERR_6	Impermissible value
ERR_8	Module or value not available
ERR_30	Programmer, all segments occupied
ERR_31	Not possible to specify a set point value. The "Setpoint offset" function is active.
ERR_32	$T_{iH} \leq T_{iL}$
ERR_33	External sensor missing
ERR_34	Analog value not present
ERR_35	Automatically configured
ERR_36	Not possible to specify set point, programmer is running or has been paused
ERR_37	Not possible to start programmer (analog set point value input is ON)
ERR_38	The operator does not have the privileges to execute the command. Another control section has exclusive operating privileges, which means that writing via this interface is not permitted.
ERR_39	Operation is not permitted. Safe Mode is active.
ERR_40	Operation is not permitted. Safe Mode is switched off.
ERR_41	Operation is not permitted. Constant temperature equipment is in error status.

5 Commissioning

5.1 Establishing a mains connection



DANGER!
Transport damage

Electric shock

- Closely inspect the device for transport damage prior to starting up.
- Never operate a device that has sustained transport damage!



DANGER!
Contact with voltage conductors due to faulty power supply cable

Electric shock

- The power supply cable must not come into contact with hoses containing heat transfer liquid or other hot parts.



NOTICE!
Use of impermissible mains voltage or mains frequency

Device damage

- Compare the rating label with the available mains voltage and mains frequency.

Please note:

Personnel: ■ Operating personnel

1. On the installation side, a type B ground fault circuit interrupter is required, which also detects direct current components. Type A is not permitted!
2. ■ Only connect the device with a power cable to a socket with a protective earth conductor (PE). Only use the installed power cable for the power supply.
■ The mains plug on the device is the primary mains disconnection device. The mains plug must always be easily accessible so that it can be unplugged from the socket.



When the safety interface is not being used, the short-circuit plug must be plugged into the safety interface! Otherwise the device will not start.

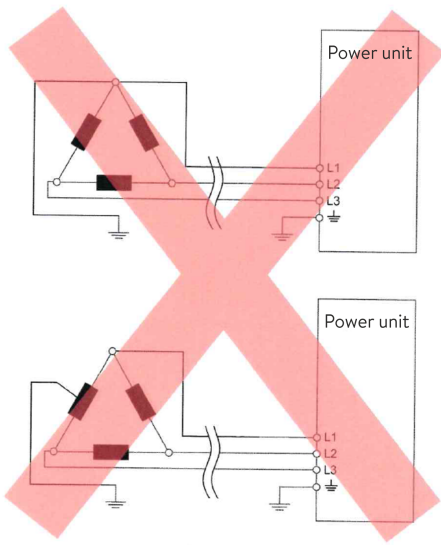

Fig. 17: Asymmetrically grounded delta network (without isolating transformer)

Notes for electric installation on site

- The fuse on the installation side must at least correspond to the maximum current consumption of the device (see type plate) and may not exceed the value permitted for the mains plug.
- Three-phase devices
 - Three-phase devices may only be operated on networks grounded at the neutral point, e.g. TN-C, TN-C-S or TN-S. For ungrounded networks (e.g. IT systems) or asymmetrically grounded networks, an isolating transformer must be connected upstream and the neutral point grounded. When selecting the isolating transformer, consider the maximum connected loads of the device.
 - Ensure correct rotating field! If the rotating field is incorrect, an error message is displayed and the device cannot be put into operation.

5.2 Switching on the device for the first time

After being connected to the power supply, the device can take up to three minutes to initialize. Only after this time can the device be switched on using the mains switch.

You will find the entry sequence prescribed for safety reasons in the graphic. The entries must be input each time the heat transfer liquid is changed and after the device has been switched on for the first time.

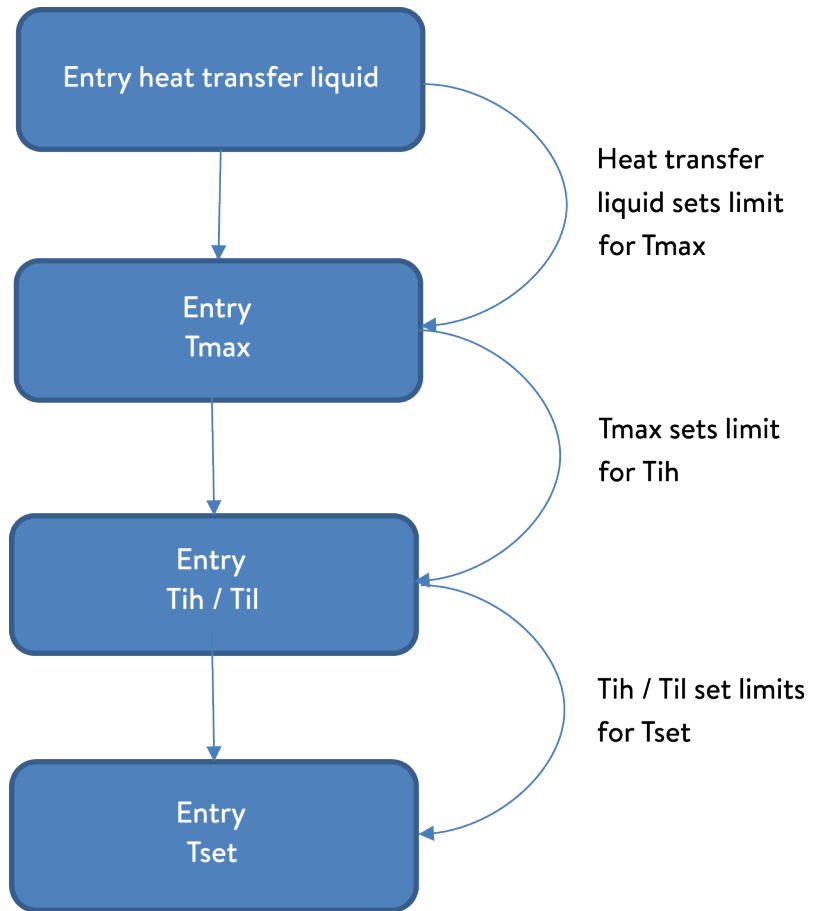

Fig. 18: Entry sequence



Do not switch on the device at the main switch until all hydraulic connections for the application have been fully established and all measures for safe commissioning have been implemented.

Switch on the device

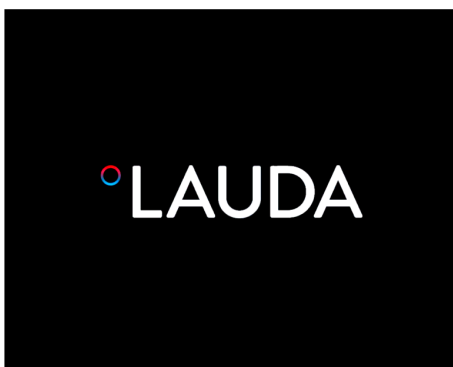

Fig. 19: Start screen

1. Switch on the device at the mains switch. A signal tone is emitted.
 - ▶ The language selection menu then appears.



Fig. 20: Menu language

2. Use the up and down arrow keys to select the desired [menu language].
Press the [CONTINUE] softkey to confirm your selection.

i You can change the menu language at any time via the menu.

- ▶ The time zone selection menu then appears.
3. Use the up and down arrow keys to select your current [Time zone].
Press the [CONTINUE] softkey to confirm your selection.
 - ▶ The heat transfer liquid selection menu then appears.
 4. Use the up and down arrow keys to select the [heat transfer liquid].
Press the [CONTINUE] softkey to confirm your selection.
 - ▶ The fill mode menu then appears.
 5. Fill the device with heat transfer liquid.
 - ▶ Then the degas mode menu appears.
 6. Let the device perform the degassing.
 7. Set $T_{\max/\text{Tank}}$ ↪ Chapter 6.4 “Setting the overtemperature switch-off point T_{\max} ” on page 87.

i When the device is in operation, a red light spot is projected onto the floor under the front of the device.

If there is a fault, this light point flashes. If the device is in standby or switched off, the light point is not present.

5.3 Operating the device with the operating unit

5.3.1 Home window, navigation and softkeys

Home window

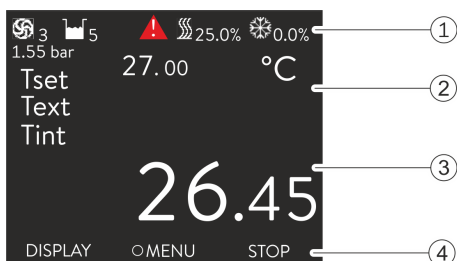

After switching on the device and configuring the settings, the "simple" home window (without status bar) is displayed. If no entry is made for about 10 seconds, the softkey bar is hidden. Press any key to display the softkey bar again.

- 1 Status bar
- 2 Display of the external temperature T_{ext} or the internal temperature T_{int} and the set temperature T_{set} .
- 3 Large display of the value to which the device regulates the temperature.
- 4 The softkey assignments are displayed in the softkey bar.

The softkeys are special keys that can be pressed at any time, but can assume different functions depending on the context. The respective function is shown in the display at the assigned position.

Fig. 21: Home window with status bar and softkey bar

Status bar

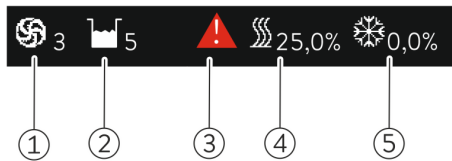

Fig. 22: Status bar from the extended home window

- 1 The pump symbol rotates while the pump is running. On the Integral IN XT, the pump level is also displayed numerically.
- 2 Display of the filling level of the heat transfer liquid in the device
- 3 A red or yellow warning triangle indicates error, alarm or warning messages.
- 4 The heater heats with the displayed percentage power.
- 5 The cooling unit cools with the displayed percentage power.

Keys, displays and softkeys

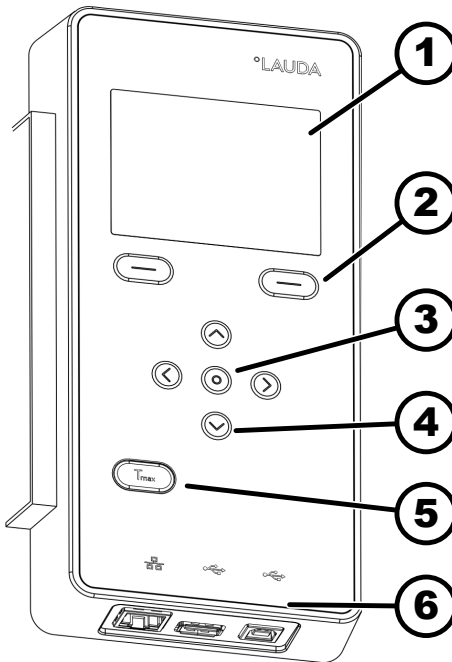

Fig. 23: Operating unit

- 1 Display
- 2 Left and right softkey
- 3 Enter key
- 4 4 arrow keys
- 5 Key to display the overtemperature switch-off point
- 6 Standard interfaces

Symbols in the menu

Symbol	Description
▶	The triangle indicates that there is a submenu.
🔒	The padlock indicates that this menu cannot be changed.

Functions of the softkeys

The softkey row is located at the bottom of the display. Depending on the context, the softkeys are assigned several different functions.

You can select the following functions with the softkeys:

- With [DISPLAY] you switch through the different windows.
 - "simple" home window (without status bar)
 - "extended" home window (with status bar)
 - Graph window
 - List with `errors` and code number
 - List with `warnings` and code number
 - List with `alarms` and code number
- With [ESC] you exit the menu and jump back into the home window or exit an entry window.
- With [MENU]
 - you access the main menu and
 - confirm the selected menu command which takes you deeper into the submenu or to an entry window.
- With [OK]
 - you confirm an option in a selection window and
 - confirm a numerical value in an entry window.
- With [CHANGE] a device parameter (for example set temperature) is changed.
- With [SELECT] an element is selected in a selection list.
- With [START] or [STOP] you can switch between the two operating modes *Standby* and *Operation*.
- With [+/-] you can enter negative values in an entry window.
- Depending on the context, further functions are assigned to the softkeys (e.g. NEW/DELETE in the programmer-editor).

5.3.2 Enter entry window and set temperature

Settings in the display are configured via the entry window. Two varieties of entry windows are available.

Entry window for selecting options



- The check mark indicates the active option.
- You can navigate in the options using the arrow keys [up] and [down].
- The selected option is highlighted.
- Press the [ESC] softkey to exit the entry window, with or without changes.
- Press the Enter key [OK] to accept the selected option.

Fig. 24: Selecting options

Entry window for a numerical value



Fig. 25: Entering a value

- The value to be entered is displayed in enlarged font. The cursor flashes under the value.
- With the [up] and [down] arrow keys you can change the value. If you keep one of the two arrow keys pressed down longer, the change will be accelerated.
- By pressing the [left] or [right] arrow key, you can select individual digits and change them with the [up] and [down] arrow keys.
- With the [+/-] softkey you can change the sign of the value.
- The displayed values *Max:* and *Min:* specify the limits for the value entry.
- With the [ESC] softkey, you return to the previous display without making any changes.
- By pressing the Enter key [OK], the set value is accepted.

Entering set temperature

1. Press the Enter key to open the menu.
2. Select the → *Set temperature* menu item.
3. Press the Enter key.
 - ▶ The entry window appears. The cursor flashes under the temperature value. The upper and lower temperature range is displayed.
4. Change the value with the arrow keys.



By pressing the [ESC] key, you return to the previous menu without making any changes.

5. Press the [OK] to confirm the new value.
 - ▶ The new value is active.

5.3.3 Graph window

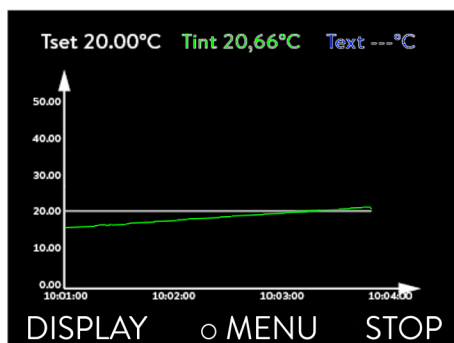

Fig. 26: Graph window

The display offers you the possibility to display temperature curves graphically.

The graphics window can be accessed via the [Display] softkey in the home window of the display.

- T_{set} indicates the set temperature (gray).
- T_{int} indicates the internal temperature (green) of the heat transfer liquid in the device.
- T_{ext} indicates the external temperature (dark blue) of the heat transfer liquid in the application.
- Use the arrow keys to scroll the graphic in any direction.

Edit the graphic window

1. Press the Enter key to open the menu.
2. Select the → *Graphic* menu item.
 - ▶ The Graphic submenu opens.

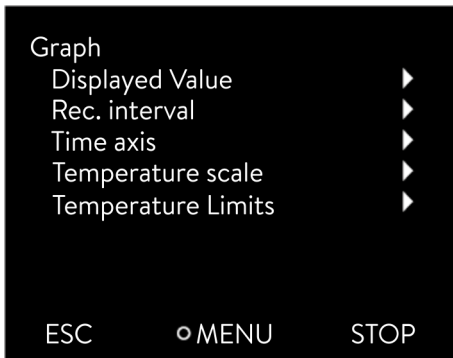

Fig. 27: Graphic menu

In this submenu, you can adapt the graphics window to your requirements.

- [Display measurement values]: T_{set} , T_{int} , T_{ext} and T_{ext2} .
Here you can define which temperatures are displayed in the graph.
- [Sample time]: 2 s (maximum 50 min), 10 s (maximum 4 h), 30 s (maximum 12 h), 1 min (maximum 24 h) or 2 min (maximum 48 h).
Here you can define the time interval at which new temperature values are measured.
- [Time Axis]: auto, 9 min, 45 min, 2 h15 min, 4 h30 min, 9 h, 24 h or 48 h.
Here you can define the time range displayed in the visible graph window (corresponds to scaling of x axis).
- [Temperature scale]: automatic or manual.
Here you can define which temperature range is displayed in the visible graph window.
 - [Autom.]: The size of the visible graphic area automatically adapts to the changing temperature curves.
 - If the setting is selected automatically, the following menu item (Temperature limits) is not visible.
- [Temperature limits]: T.scale Min and T.scale Max.
Here you can manually define which time range is displayed in the visible graph window.

5.3.4 Operating the device with the Command Touch

The device can also be operated using the Command Touch remote control (accessory).



WARNING!
Device start carried out from remote control unit

Scalding, slipping, environmental hazard

- Do not switch on the device until all hydraulic connections for the application have been fully established and all measures for safe commissioning have been implemented.

Do not switch on the device at the main switch until all hydraulic connections for the application have been fully established and all measures for safe commissioning have been implemented.



The accessories, filling and draining unit, and through-flow regulator are not implemented in the Command Touch remote control.

5.4 Setting the heat transfer liquid



WARNING! Use of unsuitable heat transfer liquid

Fire, mutation, poisoning, environmental hazard, equipment damage

- Heat transfer liquids from LAUDA are recommended.
- If you wish to use your own heat transfer liquids, you must check that the fluids are suitable for the materials used. The heat transfer liquid must be provided with corrosion protection. You must also test the suitability of the liquid by performing a test run within the desired temperature range. During the test run, you must also check the low-level protection.
- Select a heat transfer liquid with a temperature range suitable for the application.
- Do not use any heat transfer liquid above the flash point in the expansion vessel.
- Do not use any heat transfer liquid more than 100 K below the ignition temperature.
- Do not use any heat transfer liquid that is radioactive, toxic or environmentally hazardous.
- Do not use ethanol or methanol because their flash point is below normal ambient temperature.
- Do not use deionized water as a heat transfer liquid.
- Only use heat transfer liquids that are approved for heat transfer systems.
- Use heat transfer liquids with a kinematic viscosity of less than 180 mm²/s during operation.
- Use heat transfer liquids with a density in the range of 0.75 to 1.8 g/cm³.
- Only use heat transfer liquids (glycol/water-based) with a freezing point below -52 °C.
- Only use heat transfer liquids (except glycol/water) with a freezing point below -70 °C.
- For cascades, only use heat transfer liquids with a freezing point below -100 °C.

In the menu of the device, set the heat transfer liquid used in the device. This process loads the values entered in the software into the controller of the device.

The entered values of the heat transfer liquid are:

- the flash point
- the viscosity
- the density
- the specific heat capacity
- the limits of the working temperature range in the hydraulic circuit
- the limits of the temperature range in the expansion vessel (only for Integral IN XT)

If you select the heat transfer liquid setting [Undefined], you can enter the properties of a new heat transfer liquid in the [Define heat transfer liquid] menu item.

Personnel: Operating personnel

1. Press the Enter key to open the menu.
2. Select the menu items → *Setup* → *Fluid* → *Select fluid*.
 - ▶ A list with the permitted heat transfer liquid for the device is displayed.
3. Scroll to mark a heat transfer liquid.



Press the [ESC] key to return to the home window without making any changes.

4. Press [OK] to confirm the selection.
 - ▶ The selection is marked with a check mark.
5. In the menu item → *Display fluid properties*, you can display the properties of the heat transfer liquid.



Set Tmax immediately

After you have selected the heat transfer liquid, immediately set the overtemperature switch-off points $T_{max/tank}$
↳ Chapter 6.4 “Setting the overtemperature switch-off point Tmax” on page 87.

5.5 Filling the device with heat transfer liquid

LAUDA is not liable for damages resulting from the use of unsuitable heat transfer liquids.

Do not mix different heat transfer liquids together!

Use a funnel if required to fill the device with heat transfer liquid. The procedure for filling a device with a pressure pump is described in ↳ “Filling with a pressure pump (optional)” on page 71.



WARNING!

Overheating of the heat transfer liquid in the thermostatic circuit

Fire

- In the device menu, select the LAUDA heat transfer liquid used in the device.
- If you use your own heat transfer liquid, you must enter the correct liquid parameters in the device menu.
- Set the overtemperature switch-off point Tmax, but not above the permissible temperature range of the heat transfer liquid.



WARNING!
Overheating of the heat transfer liquid in the return flow

Fire

- Set the overtemperature switch-off point T_{max} , but not above the permissible temperature range of the heat transfer liquid.
- Take into account exothermic processes in the application (heat input by the application) to prevent the temperature at the outlet nozzle from exceeding the permissible temperature range of the heat transfer liquid.



WARNING!
Overheating of the heat transfer liquid in the expansion vessel

Fire

- In the device menu, select the LAUDA heat transfer liquid used in the device.
- If you use your own heat transfer liquid, you must enter the correct liquid parameters in the device menu.
- Set the overtemperature switch-off point T_{max_Tank} , but not above the flash point of the heat transfer liquid or above the ignition temperature of the heat transfer liquid minus 100 K.



WARNING!
Splashing heat transfer liquid

Eye damage

- Always wear suitable safety glasses when working on the device.



CAUTION!
Overflow of heat transfer liquid

Slipping or falling over

- Do not overfill the device. Please note the level display and keep in mind that the heat transfer liquid will increase in volume when heated (for the total volume with application and hoses).



CAUTION!
Spraying of heat transfer liquid

Slipping or falling over

- Use a funnel for filling.



CAUTION!
Risk of heat transfer liquid escaping

Slipping or falling over

- Drain tap must be closed.
- Ensure that all hydraulic connections are tight.



Heat transfer liquids expand when heated (approx. 10 % for every 100 °C). If an external application is connected, expansion occurs exclusively in the thermostat tank.

- Avoid ignition sources in the vicinity of the cover and overflow hose.
- There must be no gas cushions in the consumer system.

Information on filling the device

- Refilling during operation is possible.
- Only operate the thermostat if a flow in the consumer system is possible. Open any shut-off valves in the consumer.
- During filling, the device may overflow if the consumer is positioned higher than the device and filling is interrupted (e.g. due to a power failure). There may be even larger amounts of air in the consumer, which allows the filled liquid to flow back. In case of doubt, a shut-off valve should be attached to the lower connection of the application.
- A vent valve Fig. 28 can significantly simplify the aeration process. For this purpose, periodically open the valve carefully and allow gas/air to escape until liquid escapes from the valve, and then close the vent valve again. Collect the liquid in a suitable container. Operate the valve again at regular intervals until no more air escapes.

Information on filling mode

- Filling mode helps you fill the device. Messages in the display guide you through the filling process. Follow the instructions and switch on the display with the [>>] softkey.
- Furthermore, the fill mode removes gas bubbles and air bubbles from the thermostatic circuit. The pump starts automatically at pump level 2 and switches off briefly every 45 seconds for better aeration. Heating and cooling unit are switched off. Observe the pressure indication and level indication until the level no longer drops, the pressure indication no longer rises and the degassing symbol is no longer displayed for at least two minutes. Venting takes at least a few minutes and can take more than an hour in unfavorable conditions with large-volume consumers and high viscosity.



If [Fill mode] is active, the device does not heat or cool. You can only start the device after end [Fill mode].

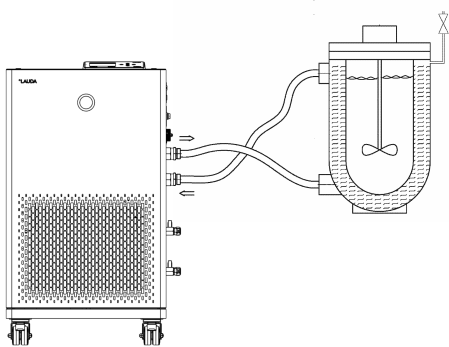

Fig. 28: Application with vent valve

5.6 Filling an IN XT device

Filling an empty device

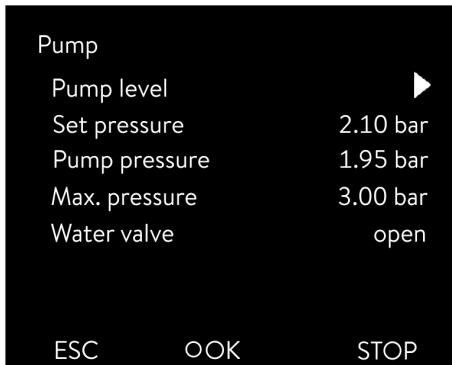

Fig. 29: Pump menu in Integral IN XT

Protective equipment: ■ Safety glasses
 ■ Protective gloves
 ■ Protective work clothing

1. Close the drain tap or taps. To do this, turn the tap clockwise.
2. Attach a suitable hose (heat transfer liquid/temperature) to the overflow pipe on the device.
3. Place the end of this hose into a suitable canister to collect the overflowing heat transfer liquid.
4. Switch on the device.
 - ▶ If the tank is empty (level 0), the *fill mode* is started immediately after switching on the device.

5. Remove the tank lid. Use a funnel for filling, if required.
6. Carefully fill with heat transfer liquid. Check the level indicator and do not overfill the device!

Recommendation: Fill the device up to level 6.

7. Carefully top up the heat transfer liquid. Check the level indicator and do not overfill the device!

The device supports you additionally with a signal tone from level 11 onward. To begin with, the signal tone is emitted at longer intervals. From level 12, the sound is repeated at shorter intervals. Once the **fill maximum is reached**, a continuous tone is output.

Filling with a pressure pump (optional)

We recommend the B2 Vario drum pump from Lutz for non-flammable heat transfer liquids.

The device is filled via the filling nozzle with the non-return valve.

The constant temperature equipment has been switched off and compressed air is not required for filling.

1. Completely assemble the hydraulic circuit (with application, hoses, constant temperature equipment and any additional equipment).
2. Prepare the heat transfer liquid.
3. Immerse the pressure pump in the container with the heat transfer liquid.
4. Unscrew the sealing cap from the filling nozzle of the device. See the item "Filling nozzle with non-return valve" in the device graphic in or .
5. Connect the drum pump to the filling nozzle of the device (G 3/8" exterior thread (male)).
6. Open the filling tap. To do this, turn the tap counterclockwise.
7. Switch on the constant temperature equipment with the mains switch and switch it to standby.
 Have the fill level of the constant temperature equipment shown in the display and monitor the fill level during filling.
8. Fill the constant temperature equipment with the pressure pump.



9. Once the desired fill level has been reached, close the tap on the filling nozzle. Switch off the pressure pump. Remove the pressure pump and screw on the sealing cap.
10. You should degas the heat transfer liquid after filling.

Refilling the heat transfer liquid

Heat transfer liquid should be pumped into the application

1. If the device is partially filled, *Fill mode* can be started manually.
→ *Main menu* → *Fill mode* → *Start filling*.
2. Select the → *Fill mode* → *Start filling* → *Start pump* menu items.
You might have to [delete the alarm] in the [Fill mode] menu.
 - ▶ Heat transfer liquid is pumped through the external consuming unit.
3. Fill up with heat transfer liquid until the desired liquid level is reached. Allow the pump to continue running during this time.

The cooling unit is switched off. The outflow temperature can rise above the set temperature due to the heat input of the pump.
4. Press [Stop filling] to exit fill mode and stop the pump.

Press [Stop pump] to stop the pump.



Activating fill mode is not necessary when refilling during operation. If necessary, switch the unit to standby mode. To do so, press the [STOP] softkey.

5.7 Degas heat transfer liquid (low boiling point expulsion)

This section is relevant for:

- Integral XT devices

Please note:

- Degas slowly and carefully, especially in the case of liquids with a high proportion of low boilers.
- There must be no gas cushions in the consumer system. Check this by reducing the pump power by one or two stages. The level indication of the device may not rise.
- To extend the temperature range of the heat transfer liquid used, nitrogen overlay in the expansion vessel is recommended.
- Ventilate the installation site. Vapors which are hazardous to health may be produced.



WARNING!

Hot heat transfer fluid above the flash point in the expansion vessel

Fire

- Degas with the degas mode.
- Ventilate the installation site. Extraction is recommended.
- Avoid sources of ignition wherever vapors can escape.

Degas mode description

- Personnel: ■ Specialized personnel
- Protective equipment: ■ Safety glasses
 ■ Protective gloves
 ■ Protective work clothing

Principle: During degassing, the heat transfer liquid is boiling. Gas can escape at various points in the circuit. For example, at the heater or at a throttle point.

The Integral IN XT device is equipped with a gravity separator upstream of the pump, through which the gas passes into the expansion vessel.

You can also use compressed air instead of an inert gas for degassing the heat transfer liquid.

The following parameters are set automatically in degas mode:

- Pump level is set to Stage 2. Only change the pump level when it is necessary.
 Caution when selecting the pump level in connection with pressure-sensitive consumers (e.g. glass apparatus)!
- The heating output is reduced to about 50 % of the total heating output of the process thermostat.
- The cooling unit is switched off. The outflow temperature can rise above the set temperature due to the heat input of the pump.
- The pump switches briefly off and on again approximately every 45 seconds.
- Do not use pressure control. Note the maximum pressure!

Degassing

1. After filling and venting, heat the heat transfer liquid up to 20 K above the subsequent maximum working temperature.

Enter the new set temperature and confirm it.



- *Note the maximum working temperature range of the heat transfer liquid.*
- *Note the maximum working temperature range of the connected consumer.*

2. Start degas mode.

In the menu, select → *Degas mode* → *Start degas mode*.

▶ Degassing starts.

In order to facilitate the removal of the low boilers during degassing, it may be useful to open the tank cover so that the steam escapes more easily (if necessary, use air extraction). In this operating status, constantly check the device; make sure to keep ignition sources away from the filling opening and protect the operating personnel from splashes (e.g. place the cover diagonally on the filling opening). Appropriate protective equipment or protective clothing must be worn. After the end of degassing, close the filling opening again with the tank cover.

3. The end of degassing is reached when the outflow temperature has approached the set temperature (< 10 K) and does not continue to rise.

The end of degassing is also reached when the outflow temperature has exceeded the set temperature due to self-heating.

4. End the degas mode with → *Degas mode* → *Stop degas mode*.

▶ The device is in standby. All parameters described above are retained with their current settings.

Automatic degassing

If necessary, the device carries out the degassing automatically. If the device detects gas in the hydraulic system, the heating and cooling output is first reduced or temporarily switched off completely. If the pump pressure drops sharply (a clear sign of degassing), the pump speed is limited and the pump may be switched off briefly. When the automatic degassing is finished, the device resumes its operation automatically.

5.8 Setting the flow rate of the heat transfer liquid

Setting the pump level

This section is relevant for:

■ Integral IN XT devices

The pump of the device can be adjusted by means of several pump levels. This optimizes the flow rate and discharge pressure, noise generation and mechanical heat input.



*If you have connected a pressure-sensitive application, you must use the settings [Set pump pressure] (→ *Pump* → *Pressure control* → *Set pump press.*) and [Max. pressure] in the *Pump* menu.*

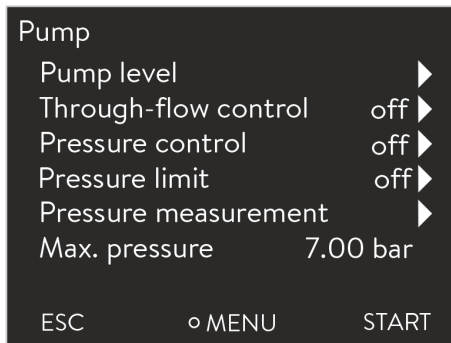

Fig. 30: Integral IN XT pump menu

Entries in the Pump menu

- Pump level
- Through-flow control
 - The flow control menu is only displayed if a flow controller has been connected (for example, FC 80 MID).
- Pressure control with entry window for the set pump pressure
 - As an alternative to the 8 pump power stages, operation with pressure control is provided. The device then regulates to the set pressure and enables a careful supply of pressure-sensitive applications.
 - You enter a value in this entry window when you have connected a pressure-sensitive application. This value in the bar unit depends on the sensitivity of your application. If you enter a set point of 0 bar, the pressure control is switched off.
- Pressure limitation
 - When operating with a pump level or through-flow control, a limit for restricting the pump pressure can be set here. This setting only becomes active if the pressure control is deactivated.
 - You enter a value in this entry window when you have connected a pressure-sensitive application. This value in the bar unit depends on the sensitivity of your application. If you enter a set point of 0 bar, the pressure control is switched off.
- Pressure measurement

No settings can be made here.

 - Pump pressure: Displays the current pressure of the pump in the outflow.
 - Outfl. Press. FC

Displays the pressure currently measured at the output of the flow controller. The menu is only displayed if a flow controller has been connected.
 - Extern Ethernet and Extern analog: Displays the externally measured pressure supplied via the interface.
- Max. pressure
 - This entry serves to protect your application. Set the maximum pressure to a level which cannot damage your connected application. The set pressure and the pressure limit must be lower than the maximum pressure. If the maximum pressure you entered is exceeded, the device switches off. Pump, heater and cooling unit are switched off.

- Personnel: ■ Operating personnel
- Protective equipment: ■ Safety glasses
 ■ Protective gloves
 ■ Protective work clothing





1. Press the Enter key to open the menu.
2. Select the menu items → *Pump* → *Pump Level*.
 - ▶ The pump levels 1 to 8 are displayed. The currently active pump level is displayed inverted.
3. Select one of the pump levels displayed.
 - ▶ The selected pump level is activated automatically. It does not have to be activated separately.

Setting the pump level

4. With the [ESC] softkey, you return to the home window, or, with the left arrow key [←], you return to the Pump menu.

6 Operation

6.1 General warnings

 DANGER! Gas displaces atmospheric oxygen	
Danger of asphyxia	<ul style="list-style-type: none"> ● Only use the inert gas overlay in areas with good aeration. ● Attach the warning symbol "Danger of asphyxiation" (ISO 7010, W041) in the vicinity of the inert gas connection.
 DANGER! Formation of a flammable atmosphere	
Explosion, burns, fire	<ul style="list-style-type: none"> ● Avoid ignition sources in the immediate vicinity. ● The maintenance and calibration periods specified by the manufacturer for the gas warning sensor must always be observed. The gas warning sensor must be replaced at the end of its service life, see chapter "Maintenance". However, local regulations may stipulate the need for earlier periodic testing and/or calibration. ● If the gas warning sensor triggers, a specialist trained in handling flammable refrigerants must identify and rectify the cause before the system can be put back into operation. ● Ensure that the minimum room size requirements are met, see chapter "Technical data". If the minimum room size requirements are not met, additional measures must be taken, such as installation in the machinery room or outdoors.
 WARNING! Various causes (thermal)	
Fire, scalding, cold burns	<ul style="list-style-type: none"> ● The quick shutdown button must be easily accessible.
 WARNING! Unauthorized changes to safety-relevant settings	
Fire	<ul style="list-style-type: none"> ● Operation by operating personnel only.



WARNING!
Risk of cooling circuit bursting due to excessive gauge pressure

Burns, fire

- Ensure that none of the openings on the fan are blocked, including the front air inlet of the device and the air outlets.



WARNING!
Risk of cooling circuit bursting due to corrosion

Burns, fire

- Do not use corrosive heat transfer liquids.



WARNING!
Ingress of flammable refrigerant into the hydraulic circuit

Burns, fire

- Do not use corrosive heat transfer liquids.
- Only use heat transfer liquids (glycol/water-based) with a freezing point below -52°C . We recommend LAUDA Kryo 30.
- Only use heat transfer liquids (except glycol/water) with a freezing point below -70°C .
- For cascades, only use heat transfer liquids with a freezing point below -100°C .
- Set the heat transfer liquid used in the device in the device menu.



WARNING!
Splashing heat transfer liquid

Eye damage

- Always wear suitable safety glasses when working on the device.



WARNING!
Overheating of the heater

Ignition and spread of fire

- Set the overtemperature switch-off point T_{max} , but not above the permissible temperature range of the heat transfer liquid.



WARNING!
Overheating of the heat transfer liquid in the outflow

Ignition and spread of fire

- Set the overtemperature switch-off point T_{max} , but not above the permissible temperature range of the heat transfer liquid.



WARNING!
Overheating of the heat transfer liquid in the return flow

Fire

- Set the overtemperature switch-off point T_{max} , but not above the permissible temperature range of the heat transfer liquid.
- Take into account exothermic processes in the application (heat input by the application) to prevent the temperature at the outlet nozzle from exceeding the permissible temperature range of the heat transfer liquid.



WARNING!
Overheating of the heat transfer liquid in the expansion vessel

Ignition and spread of fire

- Set the overtemperature switch-off point T_{max_Tank} , but not above the
 - flash point of the heat transfer liquid and
 - ignition temperature of the heat transfer liquid minus 100 K.
- To extend the temperature range in the expansion vessel, a nitrogen overlay in the expansion vessel is recommended.



WARNING!
A functional failure of the overtemperature protection is not detected

Burns, scalding, fire

- Perform regular checks of the T_{max} function and the T_{max_Tank} function according to the maintenance intervals.

Test activities ↗ Chapter 7.6 “Checking the overtemperature protection” on page 138



WARNING!
A functional failure of the low-level protection is not detected

Burns, scalding, fire

- Carry out regular checks of the low-level protection.

Test activities ↪ Chapter 7.7 “Checking the low-level protection” on page 139

Use of flammable heat transfer liquids



WARNING!
Use of flammable heat transfer liquids

Fire

- Aeration openings on the device must not be blocked.
- Do not smoke! No naked flames!
- When working near the constant temperature equipment and the application, do not use electrical parts that can generate sparks.
- Keep the cover of the expansion vessel closed during operation.
- For the responsible department of the operator: Attach the warning symbol W021 "Warning: flammable substances" (included in the accessories) to the device in a clearly visible location.



WARNING!
Boiling heat transfer liquid escaping from the filling nozzle

Chemical and heat burns

- Never replenish hot heat transfer liquid with other fluids.



CAUTION!
Competing settings due to simultaneous operation on the device and via LAUDA.LIVE

Scalding, cold burns

- If the user allows cloud access for write commands, conflicting settings may occur (cloud, operator terminal).



CAUTION!
Contact with hot/cold surfaces

Hot and cold burns

- Never touch parts that are labeled with the warning symbol "Hot surface".



CAUTION!
Automatic device start with the timer

Scalding, cold burns, injury

- Before using the timer, ensure that all preparatory measures for intended use have been implemented!



CAUTION!
Operation and setup not possible without auxiliary aids

Ergonomic impairment

- Operators under 140 cm tall must use a step or ladder (according to current safety standards) to set up and operate the device.

The following information is only relevant for the Integral IN 1850 XTW device:



CAUTION!
Operation and setup not always possible without auxiliary aids

Ergonomic impairment

- Operators under 160 cm tall must use a step or ladder (according to current safety standards) to fill the device.



NOTICE!
Cooling water circuit is damaged by frost expansion

Device damage, environmental impact

- When decommissioning the device or if there is a risk of freezing, drain the cooling water circuit on the cooling unit. Use compressed air or an industrial vacuum cleaner (water-proof). Blow compressed air through the cooling water circuit.



NOTICE!

Detachment of the remote control due to strong tensile stress, shearing, cable breaks

Property damage

- Set the operating parameters for the Safe Mode safety fitting (application safety) beforehand.

General

- When determining the maximum process temperature, please bear in mind that the temperature in the reverse flow is higher than the temperature in the outflow in "cooling" operation. The temperature difference from the outflow to the reverse flow depends on the heat capacity of the heat transfer liquid, the pump level and the amount of heat introduced by the application.
- For high process temperatures and "cooling" operation, we recommend using the highest permissible pump level and a bypass valve, if necessary.
- If communication with the Command Touch is interrupted, the constant temperature equipment switches to Safe Mode. Therefore, set the operating parameters for the Safe Mode safety fitting (application safety) beforehand.
- To extend the temperature range of the heat transfer liquid used, a nitrogen overlay in the expansion vessel is recommended.
- You can increase or reduce the pump pressure via the pump levels.
- You can limit the pump pressure via the pressure control.
- To ensure temperature control at high loads (> 70 % cooling or heating), a sufficiently high flow rate (at least pump level 4) must be ensured, especially at viscosities above 50 mm²/s.
- The device should be operated preferably at a higher pump level (at least pump level 4, the higher the better). If the pressure in the outflow becomes too high for the application, open the internal bypass of the constant temperature equipment.
- The error message "Evaporator frozen" and/or strongly fluctuating temperatures indicate that the flow rate in the device is too low (see also ↗ Chapter 8.4 "Troubleshooting" on page 146).
- If the viscosity of non-LAUDA heat transfer liquids exceeds 50 mm²/s within the desired working temperature range (e.g. glycol-water mixture below -25 °C), you must enter the viscosity data of this heat transfer liquid in the constant temperature equipment (see also ↗ Chapter 5.4 "Setting the heat transfer liquid" on page 67). LAUDA Kryo 30 can be selected as an alternative when using a glycol-water mixture as the heat transfer liquid.
- If a low flow rate is required at high load, LAUDA recommends using a flow controller. For electrically conductive heat transfer liquids, use the FC 80 MID flow controller (LAUDA order number L003217), for other heat transfer liquids, use the FC 80 C flow controller (LAUDA order number L004110). The flow controller ensures that sufficient flow in the constant temperature equipment is guaranteed via its internal electronic bypass.

Please note:

- The device may only be moved once it has been drained. However, the device must be decommissioned beforehand.

6.2 Operating modes

The device supports two operating modes.

- In *Operation* mode, the components of the device are operational.
- In *Standby* mode, all device component are switched off. Power is only supplied to the display on the device. This operating mode is suitable for adjusting multiple settings, for example.



A program that has been started is paused in Standby mode. After activating Operation mode, the program must be resumed again manually.

6.3 Menu structure

Note: Depending on the device type or equipment, not all menu items may be displayed!

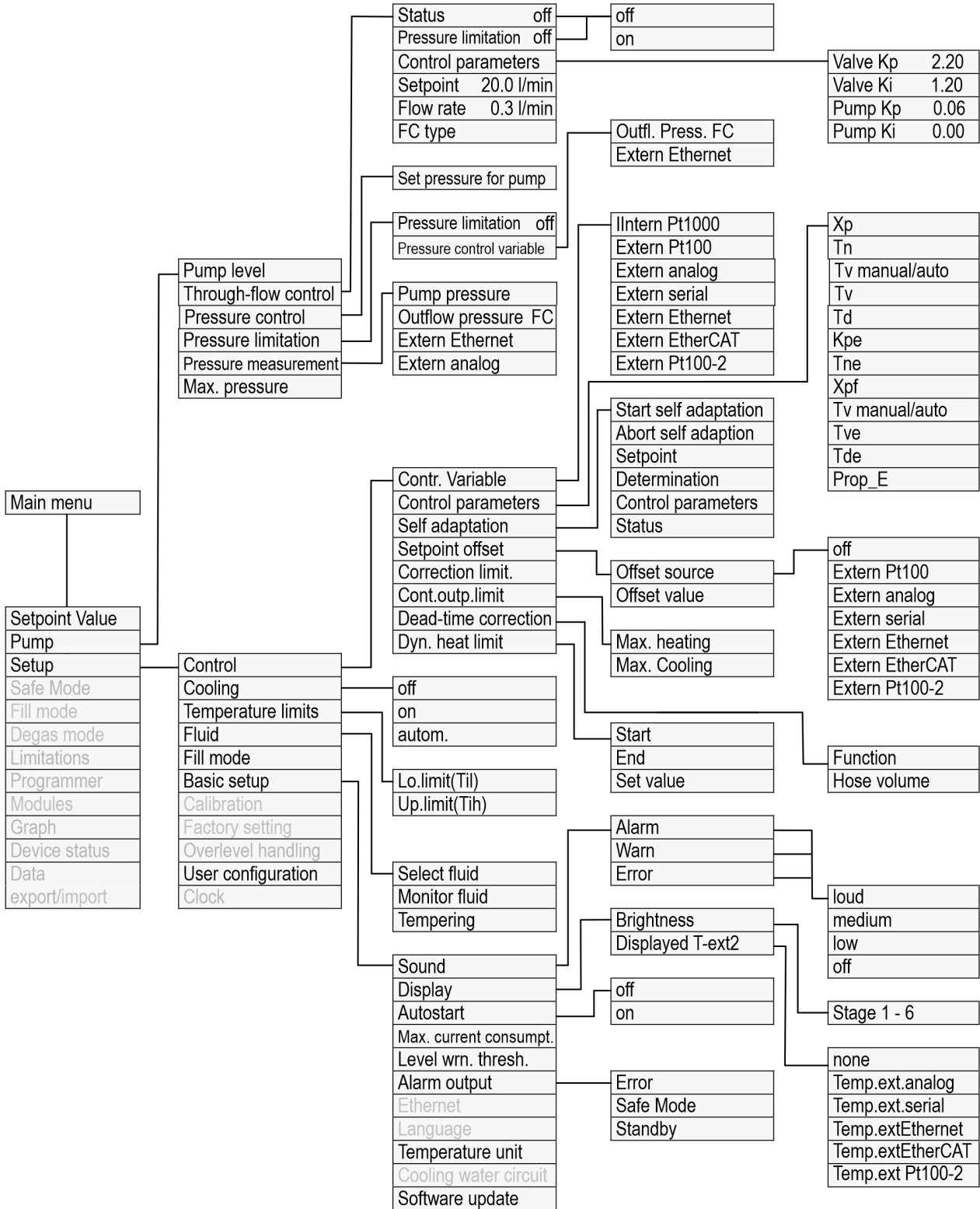

Fig. 31: Menu, Part 1

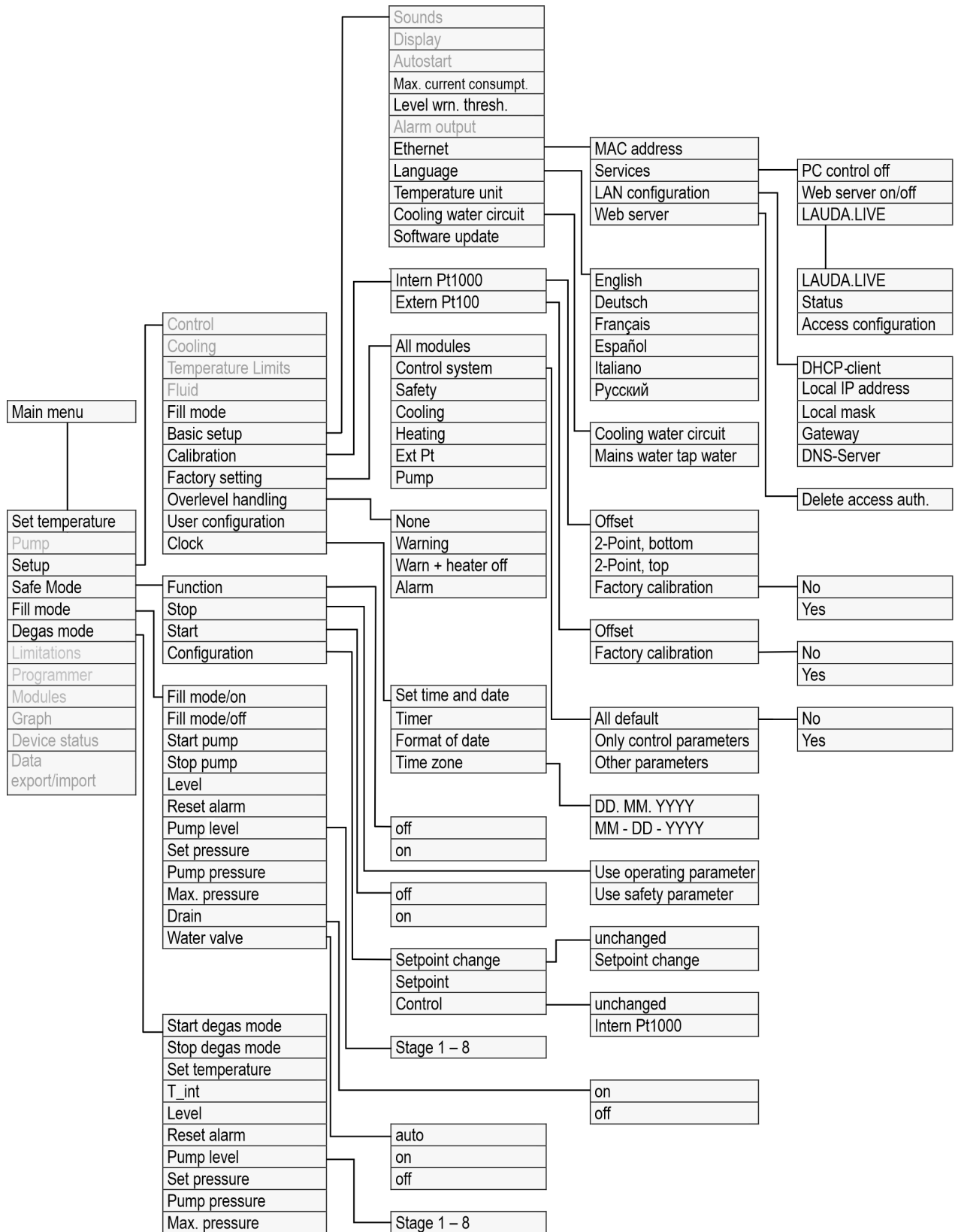

Fig. 32: Menu, Part 2 continuation from previous page

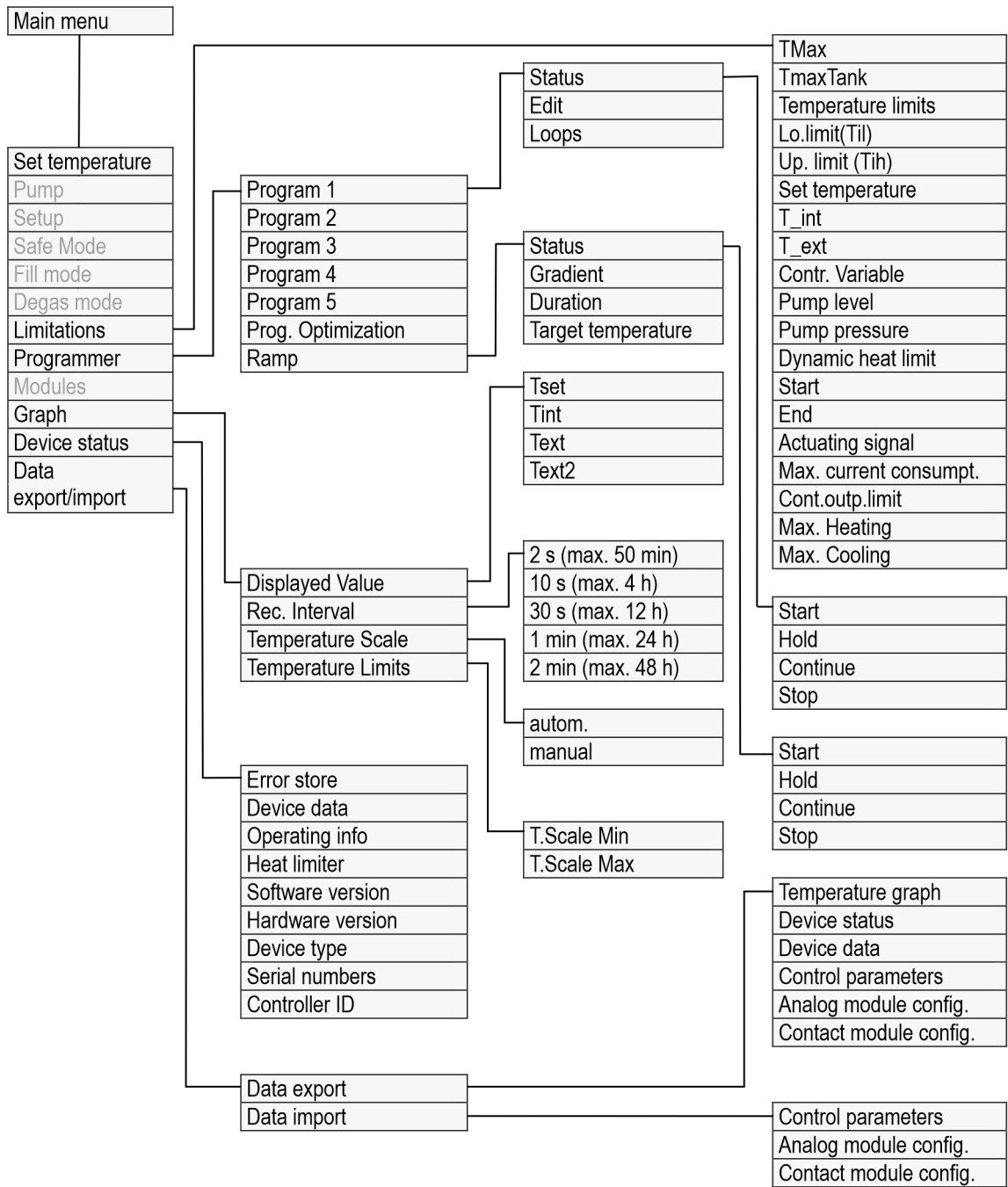

Fig. 33: Menu, Part 3, continuation from previous page

6.4 Setting the overtemperature switch-off point Tmax

Personnel: Specialized personnel

The limits for T_{max} and $T_{maxTank}$ are set automatically, as soon as the heat transfer liquid is selected in the device menu.

Consequently, the values of T_{max} and $T_{maxTank}$ are limited by the heat transfer liquid used. You can reduce the values of T_{max} and $T_{maxTank}$, but you cannot set them higher than the specified values.



Fig. 34: Displaying the Tmax value

1. Press and hold down the T_{max} key.
 - ▶ The values T_{max} and $T_{maxTank}$ appear on the display.
2. With the arrow keys select one of the two T_{max} values, while keeping the T_{max} key pressed down.



Fig. 35: Entering a new TmaxTank value

3. Press the Enter key.
 - ▶ The entry window (Fig. 35) appears. The cursor flashes under the T_{max} value or $T_{maxTank}$ value.
4. Change the value with the arrow keys.



If you release the T_{max} key, the process is aborted and $T_{max/Tank}$ was not changed.

5. Press [OK] to confirm the new value.
6. Press [ANW] softkey to confirm the new value.
 - ▶ The new value is active.



The start value is 55°C at delivery; when changing the heat transfer liquid the old $T_{max/Tank}$ value is still valid.

6.5 Set the setpoint offset

It is possible to apply an offset value to the temperature measured by an external temperature probe and then process this temperature as a target value. The setpoint of the heat transfer liquid in the device can therefore be set, for example, to 15 K below the temperature in the application, measured by the external temperature probe.

Navigating to the settings

1. Press the [Enter key] to open the menu.
2. Select the menu items → Settings → Control → Setpoint offset.

3. Select one of the following options:
 - [Offset source] allows you to select the source used to measure the offset.
 - [Diff. set/actual value] allows you to enter the value for the setpoint offset.

Entering the offset value

1. Select the [Diff. set/actual] button in the setpoint offset menu.
 - ▶ The entry window appears. An offset value can be entered within the limits displayed.
2. Enter the setpoint offset.
3. Press the [Enter key] to confirm.
4. The software returns to the previous Setpoint offset menu.

Activating an offset source

You can activate or deactivate the value entered for the setpoint offset of a corresponding source using the options in the [Offset source] menu. [External Pt100], for example, allows you to activate the setpoint offset for the external temperature probe.

1. Select the [Offset source] button in the Setpoint offset menu.
2. Select one of the following options:
 - Select [Off] to deactivate the offset source.
 - Activate an offset source from the remaining options:
 - [Extern Pt100]
 - [Extern analog]
 - [Extern serial]
 - [Extern USB]
 - [Extern Ethernet]
 - [Extern EtherCAT]
 - [Extern Pt100-2]
3. Press the [Enter key] to confirm.
4. Press the [ESC] softkey to switch to the home window.

6.6 Limiting heating and cooling

The maximum heating power or max. cooling capacity can be limited using the controller output limit. The limit is set as a percentage of the maximum value.

The controller output limit for the heating output is designed to prevent excessive temperatures on the surface of the heater. Excessive heater temperatures may degrade the heat transfer liquid.

1. Press the [Enter key] to open the menu.
2. Select the menu items → *Setup* → *Control* → *Cont.outp.limit*.
3. Select [Max. heating] and press [OK] to confirm.
 - ▶ An entry window appears. The controller output limit can be set to a value within the limits displayed.
4. Change the value accordingly.

Automatic heat limit for smaller pump power

5. Press the [OK] button to return to the previous screen with the new setting configured.
 - ▶ The new setting is active.

In the Integral XT the heat output is increasingly reduced if the pump power falls below 150 W (pump level < 4). This measure protects the heat transfer liquid from overheating on the heater surface and thus prevents premature aging of the heat transfer liquid.

6.7 Dead-time correction

The dead-time correction intervenes in the temperature control so that a stable temperature control can be achieved even with very large dead times. Use the dead-time correction if you have to operate the application with long hoses (>> 1 m) at very low flow rates (< 5 l/min).



The dead-time correction is only available if you use a flow controller (e.g. FC 80 MID) and the flow controller can measure the flow of the heat transfer liquid.

The dead-time correction is only available for external control and has no effect on internal control.

Setup

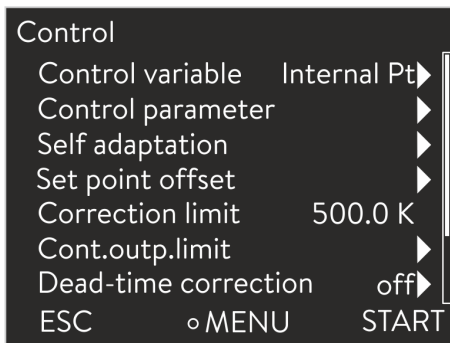

Fig. 36: Control menu

Proceed as follows to use the dead-time correction:

1. Press the [Enter key] to open the menu.
2. Select the menu items → Setup → Control → Dead-time correction.
3. Enter the volume of the hose used.



This volume can be mathematically determined just from the hose length (measured up to the temperature sensor to which is regulated) and the cross-sectional area of the hose.

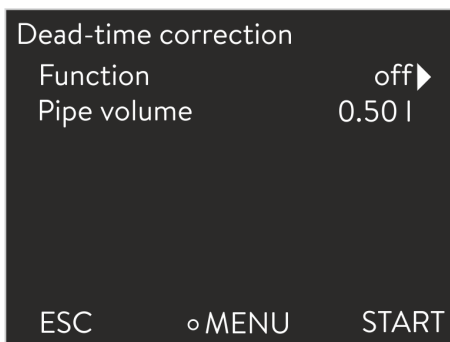

Fig. 37: Dead-time correction menu

4. Activate the dead-time correction with [Function on].



The dead-time correction means that the control system reacts much more quickly and that different control parameters can be set than in the case of normal external control as a result of the principle. In particular, significantly shorter reset times can be set for use of the dead-time correction.

The control parameters should be customized to the respective application when using the dead-time correction. On the whole, this results in significantly better control action in typical applications.

6.8 Dynamic heat limiter

With the dynamic heat limiter, you limit the heating output of the device. At low flow rates at the heaters, there is a risk that the heat transfer liquid will overheat locally. This can lead to premature aging, oil cracking with silicone oils (depolymerization) or boiling.

Example

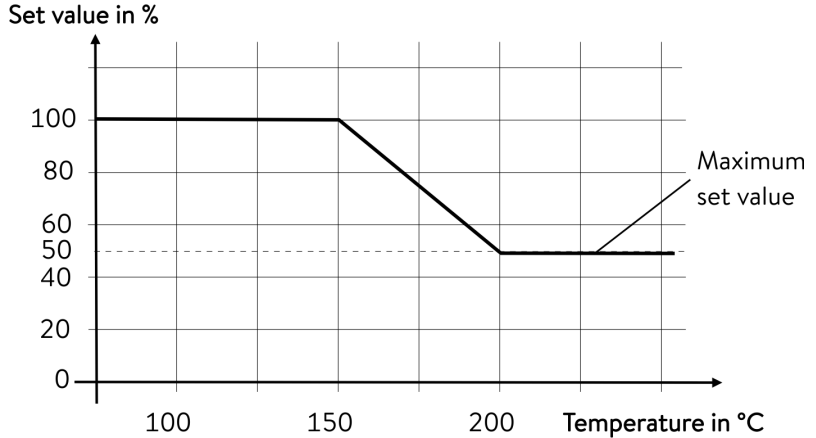

Fig. 38: Dynamic heat limiter

Start	150 °C
End	200 °C
Actuating signal	50 %

Personnel: Operating personnel

1. Press the Enter key to open the menu.
2. Select the menu items → *Setup* → *Control* → *Dynamic heat limit*.
 - ▶ The submenu opens.
3. Enter your values and press the Enter key to confirm.

Menu items	Description
Start	You use the values for Start and End to specify a temperature range, in which the power of the heater is linearly limited to the entered value of the actuating signal. The heater works at reduced power above the entered end temperature ([End]). The heater works at full power below the entered start temperature ([Start]).
End	
Actuating signal	You enter the value for limitation of the heating output in percent here.

- ▶ The dynamic heat limiter is active.

6.9 Cooling

The cooling unit of the devices is operated in the standard setting [autom.] Depending on the temperature and operating status, the cooling unit is automatically switched on or off. You can switch the cooling unit on or off permanently via the menu. In the case of sensitive control processes, control fluctuations can be prevented by automatically switching the cooling unit on or off.

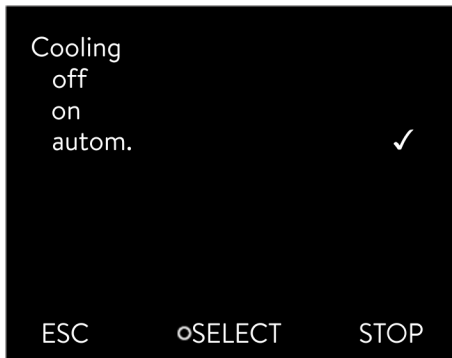

Fig. 39: Configuring cooling

1. Press the Enter key to open the menu.
2. Select the menu items → *Operating mode* → *Cooling*.
3. Select one of the following options:
 - With the [autom.] setting, the cooling unit is switched on and off automatically according to requirements.
 - With [off], the cooling unit remains switched off.
 - With [on], the cooling unit cools permanently.
4. Press [OK] to confirm the selection.

6.10 Setting temperature limits Tih and Til

This function is used to set temperature limits Tih and Til. The temperature limits limit the set temperature. A warning is issued if the internal actual temperature is outside the temperature limits. These temperature limits should reflect the limits of your application. A tolerance of 2 K should also be added to the upper and lower temperature limits to compensate for overshooting by the control, in particular external controls. The working temperature range of the heat transfer liquid must also be taken into consideration when defining temperature limits.

Setting Tih and Til

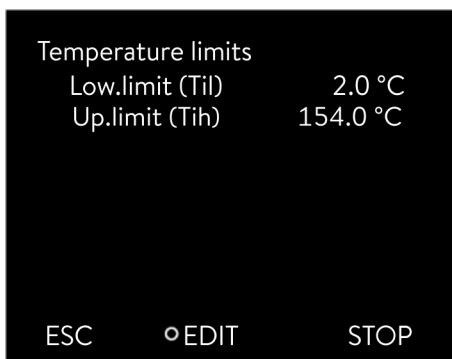

Fig. 40: Define temperature limits

1. Press the Enter key to open the menu.
2. Select the menu items → *Setup* → *Temperature limits* → *Lo.limit (Til)* or → *Up.limit (Tih)*.
 - ▶ The entry window appears. The cursor flashes under the value. The upper and lower temperature range is displayed.
3. Change the value with the arrow keys.

i *By pressing the [ESC] key, you return to the higher-level menu without making any changes.*
4. Press the Enter [OK] key.
 - ▶ The value is accepted.

6.11 Lock and release operating buttons

The operating buttons can be locked in order to protect the device when using a process control system or against unauthorized access.

Lock the operating button

Personnel: Operating personnel

1. Switch to the main menu.
2. Press and hold down the [input button].
3. Press and hold down the [Down] arrow button within 4 seconds.
4. Hold down both buttons for 4 seconds.
 - ▶ In the display the descriptions of the buttons are replaced by [---].
The entry function is now locked.

Release operating buttons

Personnel: Operating personnel

1. Press and hold down the input button.
2. Press and hold down the [Down] arrow button within 4 seconds.
3. Hold down both buttons for 4 seconds.
 - ▶ In the display the descriptions of the buttons show up again.
The device can be operated again.

6.12 Basic settings

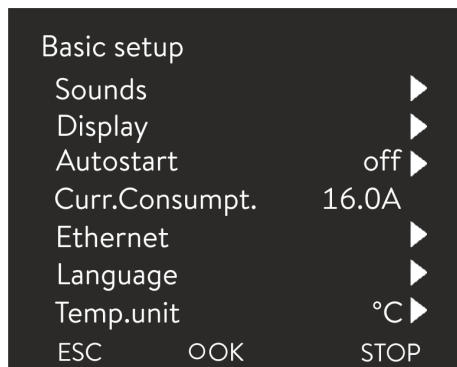

Fig. 41: Basic settings menu

Personnel: Operating personnel

1. Press the Enter key to open the menu.
2. Select the menu items → *Setup* → *Basic setup*.

The basic settings are described on the following pages.

Adjusting the volume of the sounds

The device indicates alarms, warnings and errors both visually and acoustically.

In the menu, you can adjust the volume of the sounds for:

- Alarm
- Warning
- Error

The volume settings are:

- loud
- medium

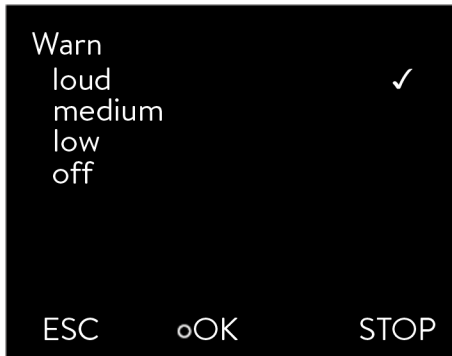

Fig. 42: Adjusting volume

Set the brightness of the display



Fig. 43: Adjusting brightness

Displayed temperatures in the display

Automatic start after power failure

- low
- off

1. In the Basic setup menu select the menu item → *Sounds*.
 - ▶ A list containing the sounds opens.
2. Select the sound that you wish to change using the arrow keys.
3. Press the Enter key to confirm your selection.
 - ▶ A list containing the volume settings opens.
4. Select a volume setting using the arrow keys.
5. Press the Enter key to confirm your selection.
 - ▶ The new setting is active.

The display brightness can be set manually.

1. In the Basic setup menu select the menu item *Display* → *Brightness*.
 - ▶ A list containing the settings opens.
2. The following options are available in the window:
 - You can select the brightness manually with entries [Level 1 - 6]. The brightness intensifies from [Level 1].
 - ▶ The new setting is valid with immediate effect.

In the [Displayed T-ext2] menu you can select via which interface a **second** external temperature value is read into your device. The newly selected temperature value is displayed in the home window and in the graphic window.

1. In the Basic setup menu select the menu item → *Display* → *Displayed T-ext2*.
 - ▶ A list containing the settings opens.
2. Select the external temperature with the arrow keys, which you would also like to be displayed.
 - ▶ The measuring channels are displayed which are installed in the device.
3. Press the Enter key to confirm your selection.
 - ▶ The new setting is active.

After a power failure and restoration of the power supply, the device **does not** resume operation (default setting). However, you can set the device to automatically resume operation after the power is restored.

1. In the [Basic setup] menu, select the menu item → *Autostart*.
 - ▶ A list containing the settings opens.

2. Select one of the following options:
 - With [Off], the device is set to standby operating mode after a power failure and when the power supply is restored.
 - With [On], the device is set automatically continue after a power failure and when the power supply is restored.



Automatic running of the device may result in unattended operation.

3. Press the Enter key to confirm your selection.
 - ▶ The new setting is active.

Limiting the current consumption

The fuse on the installation side must at least correspond to the maximum current consumption of the device (see rating label). If the mains fuse is lower, you must reduce the maximum current consumption of the device. The heating output will be reduced accordingly. When setting the current consumption, consider whether other applications may be connected to a fuse together with your device.



The reduction of the maximum current consumption of the device reduces the heating power and thus influences the control characteristics, where applicable.

Selecting the menu language



Fig. 44: Select language

The menu languages English, German, French, Spanish, and Italian are available for the device display.

1. In the [Basic setup] menu select the menu item → *Language*.
 - ▶ A list containing the languages opens.
2. Select your language using the arrow keys.
3. Press the Enter key to confirm your selection.
 - ▶ The new setting is valid with immediate effect.

Select temperature unit

In the [Temp. unit] menu you can select in which unit the temperature value is displayed. In general, this setting is valid for all windows in the display.

1. In the [Basic setup] menu select the menu item → *Temp. unit*.
 - ▶ A list of the options opens.
2. Select one of the following options:
 - With [°C] all temperatures are displayed in °Celsius.
 - With [°F] all temperatures are displayed in °Fahrenheit.
3. Press the Enter key to confirm your selection.
 - ▶ The new setting is valid with immediate effect.

6.13 Calibrating the temperature probe



A calibrated reference thermometer with the desired level of accuracy is necessary. Otherwise you should not change the calibration of your constant temperature equipment.

If, when checking the temperature in a steady state, you discover a constant temperature deviation of T_{int} or T_{ext} from the reference thermometer, this can be equalized out via the *Calibration* menu point.

With the menu point *Offset* (1-point comparison), the characteristic of the temperature switch is adjusted in parallel by the input value.

With the menu point *2-point calibration* (2-point comparison), the characteristic of the temperature switch is adjusted and the slope of the characteristic is changed.



It is possible to change the T_{int} and T_{ext} temperature values within a range of ± 3 K respectively.

Offset

- For calibration, the reference thermometer must be installed according to the specifications on the calibration certificate. The position of the reference thermometer on the pressure side between the connecting sleeve on the thermostatic circuit pressure side and the application should be as close as possible to the application to guarantee precision temperature control.
- To measure the temperature, wait until the system is in a steady state.
- 1. Press the [Enter key] to open the menu.
- 2. Select the menu items → *Settings* → *Calibration* → *intern Pt1000* or → *extern Pt100* → *Offset*.
 - ▶ The Input window opens.
- 3. Enter the temperature value read from the reference thermometer into the entry window.
- 4. Press [OK] to confirm the new value.
 - ▶ The new value has been accepted.

2-point calibration

- For calibration, the reference thermometer must be installed in the inlet of the device according to the specifications on the calibration certificate.
- The upper and lower temperature measurement points must be at least 40 K apart.
- To measure the temperature, wait until the system is in a steady state.
- 1. Set a low T_{set} setpoint on the device.
- 2. Wait until the setpoint and the temperature of the heat transfer liquid have equalized out.
- 3. Press the [Enter key] to open the menu.

4. Select the menu items → *Settings* → *Calibration* → *intern Pt1000* or → *extern Pt100* → *2-Point, bottom*.
 - ▶ The Input window opens.
5. Enter the temperature value read from the reference thermometer into the entry window.
6. Press [OK] to confirm the new value.
 - ▶ The lower value has been accepted.
7. Set a high T_{set} setpoint on the device.
8. Wait until the setpoint and the temperature of the heat transfer liquid have equaled out.
9. Select the menu item [2-Point, top] in the *Calibration* menu.
 - ▶ The Input window opens.
10. Enter the temperature value read from the reference thermometer into the entry window.
11. Press [OK] to confirm the new value.
 - ▶ The upper value has been accepted. 2-point calibration has been completed.

Restore factory calibration

Use this menu item to restore the calibration configured in the factory.

1. Press the [Enter key] to open the menu.
2. Select the menu items → *Settings* → *Calibration* → *intern Pt1000* or → *extern Pt100* → *Factory calibration*.
3. Select the option [yes].
4. Press [OK] to confirm the selection.
 - ▶ This deletes the customer's calibration and restores the calibration as it was configured in the factory.

6.14 Restore the factory setting

Navigate to the Factory setting menu

1. Press the Enter key to open the menu.
2. Select the menu items → *Setup* → *Factory setting*.

Reset all modules

With the menu [All modules], the software settings of all modules of the device are reset to factory settings.

Further down in the Factory setting menu you can select and reset individual modules.

Reset control system

In the [Control system] menu, you can reset your specific settings to factory settings.

- Reset all
- Only control parameters
- Other parameters

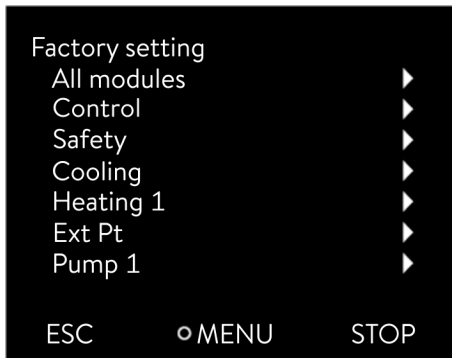

Fig. 45: Factory setting menu

Reset in the [Reset all] menu:

- Control
 - Control variable
 - Control parameters
- Temperature limits
- Basic settings
 - Sounds
 - Display
 - Autostart: On
 - Current consumption
 - Language
- Calibration
- Graphic display
- Home window
- Operating mode (operation)

Personnel: Operating personnel

1. Select the [Reset all] menu item.
2. Select one of the following options:
 - By pressing the [no] key, you return to the higher-level menu without making any changes.
 - By pressing the [yes] key, the device is reset to factory settings when you confirm this action with the Enter key.
 - ▶ The complete device is reset to factory settings.

Select and reset individual control parameters

With the menu [Only control parameters] or [Other parameters], only the selected parameters are reset to factory settings.

Personnel: Operating personnel

1. Select the [Other parameters] menu item.
2. Select one of the following options:
 - By pressing the [no] key, you return to the higher-level menu without making any changes.
 - By pressing the [yes] key, the device is reset to factory settings when you confirm this action with the Enter key.
 - ▶ The parameters are reset to factory settings.

6.15 Viewing the Device status

In the Device Status menu and its submenus, you can display lots of information and data about the device. No settings are possible in the whole Device Status menu.

1. Press the Enter key to open the menu.
2. Select the menu items → *Setup* → *Device Status*.
 - ▶ A submenu opens.

3. These menu items are available:
 - Error memory,
 - Display device data,
 - Display operating information,
 - Display heating limiter,
 - Display software version,
 - Display hardware version,
 - Display device type and
 - Display serial numbers.

Displaying the error memory

The device has an error memory for storing up to 140 warning, error and alarm messages that can be used to analyze errors.

1. Select the → *Errorstore* menu item in the Device status menu.
2. You can navigate through the list using the up and down arrow keys. The most recent message is in the top line.

The following information is displayed for each message:

- *No.* refers to consecutive numbers listed chronologically after the error occurs.
- The relevant module that triggered the message is displayed under *Source*.
- *Code* is the encoded description of the alarm, warning or error.
- *Type* specifies whether it is an alarm, warning or error.
- *Date* and *Time* display the time of the message.

The message marked above is explained in more detail at the bottom of the display.

Displaying device data

LAUDA Service uses this list for diagnostic purposes.

The device data is required for on-site service visits and telephone support.

1. Select the → *Device data* menu item in the Device Status menu.
 - ▶ Various current values of the device are displayed (e.g. temperatures).

Displaying operating information

The menu item Operating info shows how long or how often components of the device have been in use.

The service life of the components listed below is displayed in hours unless otherwise stated.

- Heat transfer liquid (fluid)
- Heating
- Pump
- Pump 2 (only appears for Integral IN 1850 XTW, IN 2050 PW)
- Compressor

- Compressor duty cycle
 - The number of switching cycles (ON - OFF) is indicated.
- EEV 0 steps
 - EEV are the electronic injection valves with the numbers 0 to 6, the opening of the valve is indicated in number of steps.

Heating limiter

The submenu displays all current limits of the device. These limits have been set by the user in other menus or have been activated by the device software based on the device configuration.

- Pump
- Current consumption
- Dynamic heat limiter
- Upper limit value (Tih)
- Degassing mode
- Fill mode
- Cont.outp.limit
- T_triac

Displaying software versions and hardware versions

The relevant versions of the installed software and hardware are required for on-site service visits and telephone support.

1. In the Device status menu select the menu item → *SW version* or → *Hardware version*.
 - ▶ The software versions installed on the device are displayed. If available, the software versions of any connected interface modules are also displayed. The hardware version is not displayed for all modules. In the case of older modules, no hardware version can be recorded by software and displayed. In such cases “- - -” is displayed.

Displaying the device type

The device type is displayed in the Device type menu item.

Displaying serial numbers

The serial numbers are required for on-site service visits and telephone support.

1. Select the → *Serial numbers* menu item in the Device Status menu.
 - ▶ The serial numbers of the device components are displayed.

6.16 Through-flow control of the internal heater



The bypass valve is used to ensure that there is sufficient flow through the heater in the device to prevent damage to the heat transfer liquid.

1. If the flow rate in the device is too low, a sound is heard for three seconds.
 - ▶ The heating switches off on all poles, the pump and the cooling unit are switched off.

2. In the display the message appears that the flow is too low.
3. Eliminate the cause.
If the reason for the low flow rate is the high flow resistance caused by the application, turn the adjusting wheel of the bypass valve counterclockwise. Turn the adjusting wheel so far until the required flow is reached.
4. Press the Enter key.
Also press the Enter key if the device was switched off in the fault state. Warnings disappear automatically when the cause is eliminated.

6.17 Programmer

6.17.1 Basic information



Fig. 46: Programmer

The programmer allows you to perform and save a temperature-time program. A program consists of several temperature-time segments. A segment contains information on the final temperature of the segment, the duration, the temperature tolerance, the pump level and the switch position (off/on) of the contact. Ramps, temperature jumps and temperature maintenance phases are possible.

The programmer of the constant temperature equipment has 5 programs. Together, these 5 programs share a total of 150 segments.

One program occupies at least one segment.

A maximum of 146 segments can be stored in one program.

Content of Program 1 – 5 menu items

- Ramp
A ramp is defined by the specified duration between the start and the end of the segment, and by the destination temperature, i.e. the temperature at the end of the segment.
- Temperature jump
If a time is not specified (time is 0), the end temperature is reached as quickly as possible.
- Temperature maintenance phase
No temperature change (the temperatures at the start and the end of a segment have remained identical).
- Pump level off or 0
 - Pump level [---] (means pump is off) can be selected within a segment. As a result, the program ends when this segment is reached, even though other segments follow in the program. The status of the thermostat is set to “Standby”. When the program is started, a message appears indicating that the program will end at this segment with pump level 0.

Program menu item



Fig. 47: Program 1

Other menu items

■ Program optimization

Activating program optimization yields a very good control action in practice. With programs including both ramps and other types of segments, the actual temperature profile matches the target temperature profile more closely than programs without optimization. It reduces overshoots. There can only be significant undershooting at the ramp ends if the control parameters are very unfavorable. Deactivate optimization in this case.

Tolerances that are too small will impair the control result. Work without tolerances where possible.

■ Ramp

In addition to the possibility of activating ramps as a segment within a program, a separate ramp function is also available.

The ramp function allows you to conveniently enter temperature changes that occur over long periods of time. The function is particularly useful for recording extremely small temperature changes (for example, 0.25 °C/day).

■ Standby

If the device switches to standby while a program is running, the active program is automatically paused.

1. Press the Enter key to open the menu.
2. Select the → *Programmer* → *Program X* menu item.
 - ▶ The submenu opens in the selected program.
3. The following options are available:
 - [Status]
 - Select the option [Start] to start the program.
 - Once the program has started, you can press [Hold] to pause it.
 - A paused program can be continued by pressing [Continue].
 - Select the option [Stop] to end the program.
 - [Edit]
 - [Loops]
 - Here you enter the number of repetitions of the selected program.
4. Select the → *Edit* menu item.
 - ▶ The program appears on the display and you can now edit it.

You can pause the programmer by pressing the [STOP] softkey. After the [START] softkey is pressed, the programmer continues to run in the previously selected mode (pause or active mode).



The programmer encoder can be controlled or modified using the timer.

Available settings

No.	Tend	hh	:mm	Tolerance
Start	30.00	---	---	0.1
1	50.00	0	20	0.0
2	50.00	0	20	0.0
3	70.00	0	20	0.1
4	60.00	0	30	0.0
5	30.00	0	0	0.0
ESC		o OK		+/-

Fig. 48: In the program editor

Setting	Description
No.	Program segment number
Tend	End temperature that should be reached
hh	Time in hours (hh) by which the specified temperature should be reached
:mm	Time in minutes (:mm) by which the specified temperature should be reached
Tolerance	Tolerance defines how close the temperature should be to the set temperature before the next segment is processed. 0.0 means that there is no tolerance. In other words, the program focuses on the next temperature when the specified time elapses, even if the starting temperature has not yet been reached.
Pump	The pump level that should be used when processing the segment can be entered.
S1, S2, S3	The switching state (off or on) of a contact module (if installed) can be entered here. Contact modules are available as an accessory.

Examples of contact module functions

Functions of the inputs

- Set fault
- Set standby
- Control programmer
- Control alternating operation (2 different set temperatures)
- Regulate internal or external control

Output functions

- Signal various error states
- Signal standby
- Specify position with respect to a temperature window (inside or outside)
- Specify the status of the programmer
- Signal refilling

Editing program examples

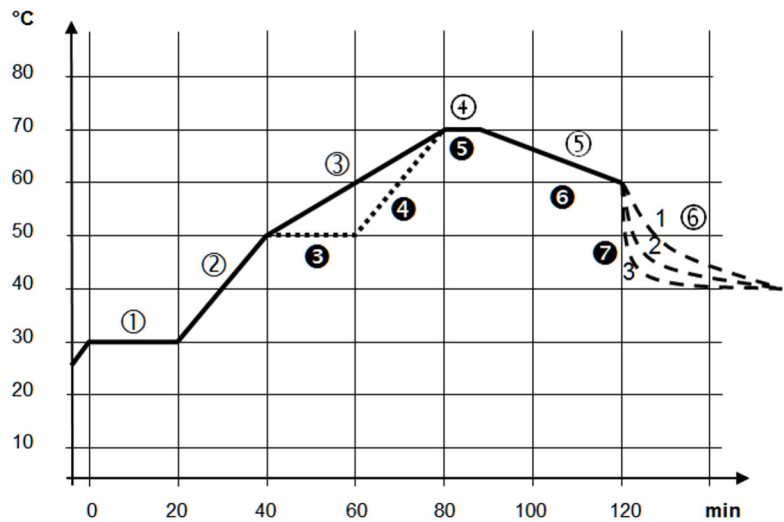

Fig. 49: Program example

The graph shows an example of a reprogrammed set temperature profile.

The cooling time in the graph varies depending on the device type, consumer and so on. In example segment number 2, 50 °C should be reached within 20 minutes.

The original values in the first table below (before) are represented by a solid line, while the values in the edited profile in the second table (after) are represented by a dashed line.

Start segment

Each program starts with the segment *Start*, which determines the temperature at which segment 1 continues the program. The temperature of the *Start* segment is reached as quickly as possible. It is not possible to specify a time limit for the *Start* segment. Without the *Start* segment, segment 1 would be different depending on the temperature of the heat transfer liquid at program start.

Table 36: Program example, before (—)

No.	Tend	hh	:mm	Tolerance	Pump	S1	S2	S3
Start	30.00	---	---	0.0	---	off	off	off
1	30.00	0	20	0.1	2	off	off	off
2	50.00	0	20	0.0	3	off	off	off
3	70.00	0	40	0.0	4	off	off	off
4	70.00	0	10	0.1	2	off	off	off
5	60.00	0	30	0.0	2	off	off	off
6	40.00	0	0	0.0	2	off	off	off

In the edited table, a new segment with the number 3 has been entered. The time and the pump level for segment 4 have also been modified. The tolerance and pump level for segment number 5 have been adapted.

Table 37: Program example, after (- - - dashed line, edited)

No.	Tend	hh	:mm	Tolerance	Pump	S1	S2	S3
Start	30.00	---	---	0.0	---	off	off	off
1	30.00	0	20	0.1	2	off	off	off
2	50.00	0	20	0.0	2	off	off	off
3	50.00	0	20	0.1	3	off	off	off
4	70.00	0	20	0.0	4	off	off	off
5	70.00	0	10	0.8	2	off	off	off
6	60.00	0	30	0.0	2	off	off	off
7	30.00	0	0	0.0	2	off	off	off

Tolerance

Note the following and see Fig. 50:

- The Tolerance field ensures strict compliance with the residence time at a specific temperature, for example.
- The subsequent segment is only processed when the outflow temperature reaches the tolerance range (1) so the ramp in the second segment is delayed and only starts at 2, for example.
- Selecting a tolerance range that is too small can cause undesired delays. In extreme cases, it may not be possible to continue the program. The selected tolerance range should not be too small, **especially if the control is external**. A greater tolerance has been entered for segment 5 to guarantee adherence to the required time of 10 minutes, even with transient responses (3).
- A tolerance range should only be programmed for flat (slow) ramps, if appropriate. Steep ramps that come close to the maximum possible heating-up or cooling rates of the device may be severely delayed (4) if the tolerance range is too small (in segment 2 here).

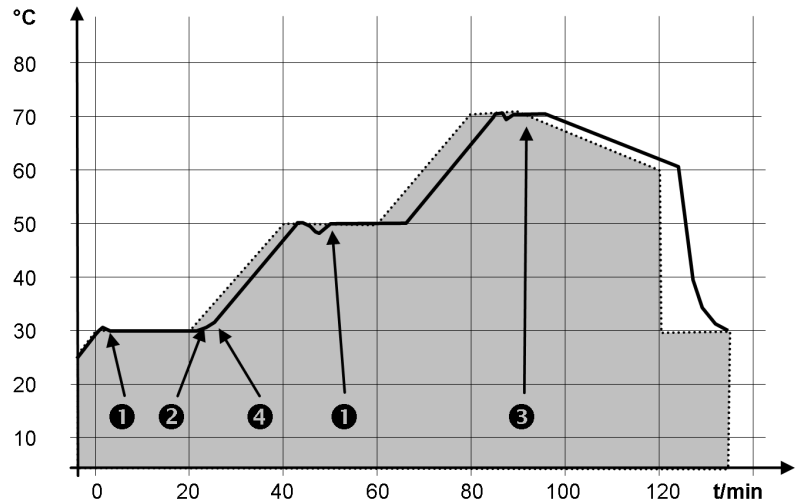

Fig. 50: Target/actual program process

The above graph of the edited process illustrates the possible delay of the actual temperature (solid line) in relation to the set temperature of the programmer (gray area).

6.17.2 Set and process program

Please note:

- If a segment time > 999:59 h is included, this time must be distributed over several successive segments.

Start processing

No.	Tend	hh	:mm	Tolerance
Start	30.00	---	---	0.1
1	50.00	0	20	0.0
2	50.00	0	20	0.0
3	70.00	0	20	0.1
4	60.00	0	30	0.0
5	30.00	0	0	0.0

ESC ○ OK +/-

Fig. 51: Editing a program

Editing a program

1. Select the *Edit* menu item for the selected program.
 - ▶ You can edit the program.

Please note:

- If in the *hh* and *:mm* field the value "0" is entered, the temperature T_{end} will be started as quickly as possible.
- Changes to the pump level are entered in the respective segment (= program line).
- The default value of the contact module is *off*.

You have the following options in the selected program:

- By pressing the right arrow key 5 times you can display the columns Pump, S1, S2 and S3 of the program.
- Use the left arrow key to display the columns Tend, hh, :mm and Tolerance again.
- With the [up] and [down] arrow keys, you can navigate to the segments (lines) of a program.
- With the [OK] you select a value for editing.
- Use the [right] and [left] arrow keys to select individual digits of the value.
- With the [up] and [down] arrow keys, you can increase or reduce the selected digit.
- With the [ESC] softkey, you can deselect a selected value again.
- With the [OK] key, you confirm your change.
- You exit the program with the [ESC] softkey. The entered values are saved.

Add new segment

No.	Tend	hh	mm	Tolerance
Start	30,00	---	---	0,1
1	50,00	0	20	0,0
2	50,00	0	20	0,0
3	70,00	0	20	0,1
4	60,00	0	30	0,0
5	30,00	0	0	0,0

ESC ◯NEW DELETE

Fig. 52: Select program segment

Delete segment

1. Navigate to the segment under which the new segment should be added.
2. In this segment, navigate to the column with the *No.*
3. Press the [NEW] key.
 - ▶ A new segment is created.

1. Navigate to the segment that you want to delete.
2. In this segment, navigate to the column with the *No.*
3. Press the *DELETE* softkey.
 - ▶ The segment is deleted.

Editing a program currently running

Please note:

- No segments can be added or deleted in a currently running program.
- In the running program, changes of the existing temperature values and segment durations are possible. The segment is continued as if the change had been effective since the beginning of the segment.
- If the new segment time is shorter than the elapsed segment time, the program jumps to the next segment.

1. Select the *Edit* menu item for the running program.
 - ▶ You can edit the segments.

6.17.3 Creating and controlling ramps

A ramp can be defined in two different ways:

- Using the gradient (K/h)
- Using the duration and target temperature

Specification using the gradient (K/h)

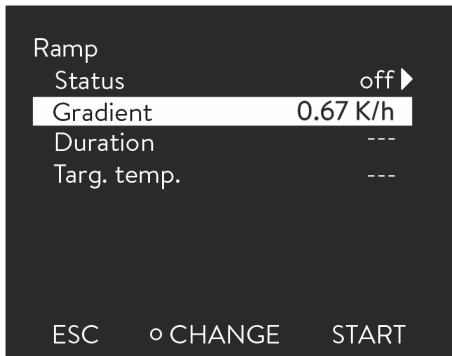

Fig. 53: Gradient

You can specify the temperature change over time using the gradient (K/h). The starting temperature corresponds to the bath or outflow temperature (or the preset external control variable) when the ramp is started. A target temperature is not defined and the ramp is active until terminated manually or until temperature limits T_{ih} or T_{il} are reached.

1. Select the menu items *Programmer* → *Ramp* → *Gradient* and enter the desired gradient (K/h) for the ramp.

Specification using the duration and target temperature

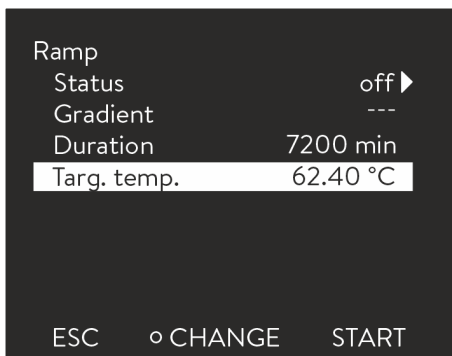

Fig. 54: Duration and target temperature

You can specify the duration (min) and target temperature (°C) of the ramp. These two parameters and the temperature at the start of the ramps determine the internal temperature gradient, which is kept constant until the target temperature is reached.

1. Select the menu items *Programmer* → *Ramp* → *Duration* and enter the desired duration of the ramp in minutes.
2. Select the menu item *Targ. temp.* and enter the desired target temperature of the ramp.



For reasons of consistency, the ramp configuration can be specified either via [Gradient] or [Duration] and [Target temperature].

Ramp status

The menu item [Status] is used to pause as well as switch the ramp function on and off. An active ramp can be paused or stopped, while a paused ramp can be continued or stopped.

Display and options with [Off] status

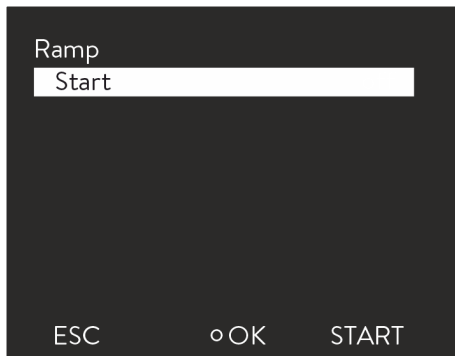

Fig. 55: Starting a ramp

1. Select the menu items *Programmer* → *Ramp* → *Status* → *Start*.
 - ▶ The ramp is started with the configured parameters.

Display and options with [On] status

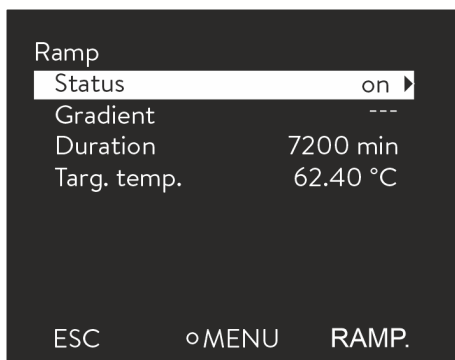

Fig. 56: Ramp status [On]

1. Select the menu items *Programmer* → *Ramp* → *Status*.
 - ▶ A submenu opens.



Fig. 57: Pausing or stopping a ramp

2. In the submenu, you can pause or stop the ramp.
 - [Hold]: The ramp is paused and the current temperature is kept constant. If the ramp was configured using the Duration and Target temperature parameters, the duration is also paused.
 - [Stop]: The ramp is stopped and the current temperature is kept constant.

Display and options with [Wait] status (pause)

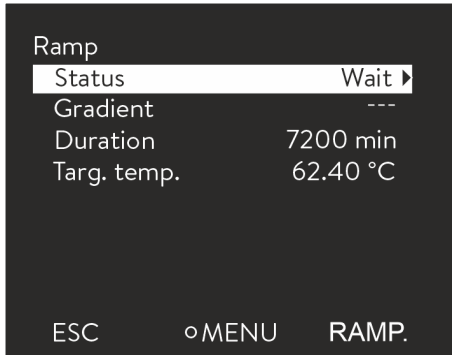

Fig. 58: Ramp status [Wait]



Fig. 59: Continuing or stopping a ramp

1. Select the menu items *Programmer* → *Ramp* → *Status*.

▶ A submenu opens.

2. In the submenu, you can continue or stop the ramp.

- [Continue]: The ramp is continued at the current temperature.
- [Stop]: The ramp is stopped and the current temperature is kept constant.

You can press the [STOP] softkey to switch the device to standby when the ramp is active or paused.



An active ramp can be interrupted or influenced by faults or interface commands, for example.

If the ramp parameters are changed while a ramp is active or paused, the active ramp will stop.

For the ramp to function correctly, the temperature must be within temperature limits T_{ih} and T_{il} when the ramp is started. The starting temperature is the same as the bath temperature or the outflow temperature (or the preset external control variable).

Examples of a ramp configuration

Example 1: Using the temperature gradient



Fig. 60: Entering the gradient

Specification of the application:

If the current bath temperature or outflow temperature (for example, 142.4 °C) should decrease by 80 °C within 5 days. Depending on the required configuration, the following values are produced:

- 5 days \Rightarrow 120 h
- Temperature gradient (K/h): $-80 \text{ K}/120 \text{ h} = -0.67 \text{ K}$

1. Select the menu items *Programmer* \rightarrow *Ramp* \rightarrow *Gradient* and enter the gradient -0.67 (K/h) .

Example 2: Using the ramp duration and target temperature

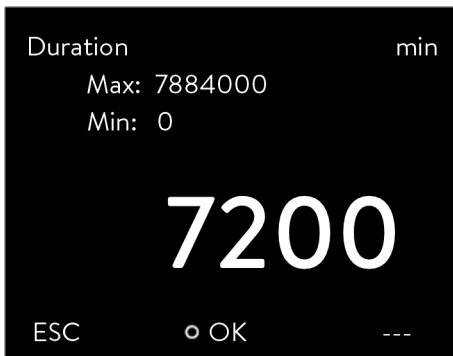

Fig. 61: Entering the duration

- Ramp duration: 5 days \Rightarrow 120 h \Rightarrow 7200 min
- Target temperature: $142.4 \text{ °C} - 80 \text{ °C} = 62.4 \text{ °C}$

1. Select the menu items *Programmer* \rightarrow *Ramp* \rightarrow *Duration* and enter the duration 7200 (min).



Fig. 62: Entering the target temperature

2. Select the menu item *Targ. temp.* and enter the target temperature 62.4 (°C).

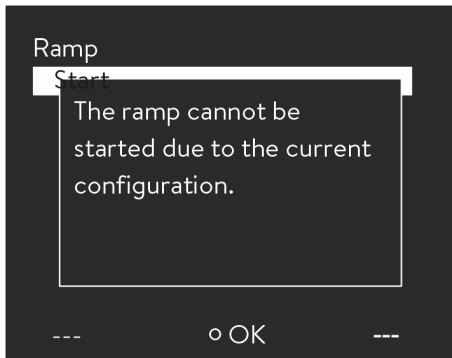

Fig. 63: Message indicating an implausible configuration



If implausible values are configured for the ramp (duration = 0 min or gradient = 0 k/h), a corresponding message appears on the display.

6.18 Set time, date, format and time zone

Set time format

The set time zone is used to convert between UTC (Universal Time Coordinated) and local time. The internal real-time clock runs in the Integral device according to UTC. The conversion then leads to the automatic changeover from standard time to daylight saving time and vice versa, since this is country-dependent. The leap years are independent of this setting as they are already included in the UTC. These entries with fixed dates for the coming decades are also included for countries that base their time zone offset on religious specifications.

UTC is also needed to obtain the time from the network because the time and date of NTP time servers are always supplied in UTC only. However, for this to work at all, the LAUDA device must be assigned an NTP time server via DHCP.

If DHCP is switched off and the IP address is permanently configured, automatic time tracking is not possible. (→ *Basic setup* → *Ethernet* → *LAN configuration* → *DHCP client*)

Only change the time/date if you have previously set the time zone. Otherwise, the local time may change due to the changed time zone offset when the time zone is changed.

Set time format



Fig. 64: Selecting options

Personnel: Operating personnel

You can display the date in two formats.

- Setting [DD.MM.YYYY] means days, month and year are displayed in this order (European).
- Setting [MM - DD - YYYY] means month, day and year are displayed in this order (US English).

1. Press the Enter key to open the menu.
2. Select the menu items → *Clock* → *Date format*.
 - ▶ A list containing the settings opens.
3. The following options are available in the window:
 - Format [DD.MM.YYY]
 - Format [MM - DD - YYYY]
 - ▶ The new setting is valid with immediate effect.

Set time and date

Personnel: Operating personnel

You can set the time and date.

1. Press the Enter key to open the menu.
2. Select the menu items → *Clock* → *Set time/date*.
 - ▶ The entry window opens.
3. Set the correct time and date.

Navigate with the four arrow keys.

 - You scroll to the corresponding point with the right and left arrow keys.
 - You change the numerical value with the up and down arrow keys.
4. Press the Enter key to confirm your selection.
 - ▶ The new setting is valid with immediate effect.

Set time zone

Personnel: Operating personnel

With the set time zone, the automatic changeover from daylight saving to standard time, correction of the date in a leap year, and so on takes place.

1. Press the Enter key to open the menu.
2. Select the menu items → *Clock* → *Time zone*.
 - ▶ The entry window opens.
3. Select your corresponding time zone.
4. Press the Enter key to confirm your selection.
 - ▶ The new setting is valid with immediate effect.



The device obtains the time and date from the network if it is operated in the network (Ethernet) with a time server. This means that the user only needs to set the time zone.

6.19 Self adaptation, temperature control

Suitable temperature control parameters can be determined automatically and adopted for the connected application using the self-adaptation function. Self adaptation can only be executed on a device with active cooling.

The self adaptation function performs a test run of the constant temperature equipment to determine the parameters. The device and application must be ready for operation.

For Integral XT, self adaptation is carried out with the currently set pump level. The best results can be expected at the highest pump levels. The pressure control of the pump can be used, but will worsen the result. If the current consumption of the device is significantly limited, the result deteriorates and the duration of the self adaptation increases.

The test run must be performed on a passive application. In other words, changes cannot be made to the application and exothermic or endothermic reactions may not occur during the test run.

The test run takes between 30 minutes and a maximum of 3 hours, depending on the application. During the run, the temperature of the heat transfer liquid deviates a maximum of ± 15 Kelvin from the defined setpoint. After completion of the test run, the newly determined values of the control parameters are accepted and stored in the [Control parameter] menu. The old control parameters are overwritten.

Start self adaptation

1. Press the [Enter key] to open the menu.
 2. Select the menu items \rightarrow *Settings* \rightarrow *Control* \rightarrow *Self adaptation*.
 - ▶ A submenu opens.
 3. Start self adaptation here:
 - [Start self adaptation]
 - The self adaptation run begins.
 - You can stop the self adaptation process prematurely by pressing [Cancel self adaptation].
 - Set point
 - Specify the temperature setpoint T_{set} here.
Take the maximum temperature fluctuations of up to maximum ± 15 Kelvin into consideration in the process.
 - Set [T_{ih}] and [T_{il}] accordingly.
 - Determination
 - With the *Only internal* command, you determine the internal control parameters.
 - With the *Internal and external* command, you determine both internal and external control parameters.
 - Control parameters
 - Here you can view the control parameters.
 - Status
 - Shows the current phase of the program for determining the parameters.
- WAIT - Self adaptation running
- END - Self adaptation ended
- SEND - Parameters are transmitted
- STOPPED - Self adaptation stopped

6.20 Control parameters

The thermal mass and the thermal connection of the application to the thermostat may make it necessary to adjust the control parameters.



Only modify the control parameters if you possess adequate knowledge of control system engineering.

6.20.1 Control basics

Definition

A brief explanation of terms

Actuating signal	- Initial value of the controller to compensate for the difference between the actual value and target value (control deviation).
PID controller	- The PID controller operates with extreme speed and precision and consists of a P, I and D-component.
Proportional range X_p	- The proportional range X_p indicates the temperature range within which the proportional component (P-component) of the controller represents 0 – 100 % of the maximum actuating signal. If the preset X_p is 10 K and the control deviation is 2 K, for example, the P-component is 20 % of the actuating signal. If the control deviation is 10 K or more, the P-component is 100 % of the actuating signal.
Adjustment time T_n	- The adjustment time is crucial for the I-component of the actuating signal. It specifies the interval at which an existing control deviation is integrated. The higher the T_n , the slower the control deviation is integrated and the more sluggish the control becomes. A small T_n makes the control more dynamic and eventually results in vibrations.
Hold-back time T_v	- The D-component of the actuating signal is formed from the hold-back time T_v . It influences the speed with which the actual value approaches the target value and counteracts the P-component and I-component. The greater the preset hold-back time T_v , the more intensively the output signal is attenuated. Rule of thumb: $T_v = T_n \times 0.75$.
Attenuation time T_d	- Attenuation time of the D-component. Rule of thumb: $T_d = T_v \times 0.15$.
Correction limitation	- Represents the maximum permitted deviation between the temperature at the external consumer and the temperature at the inlet.

Optimizing the hydraulic system

An important prerequisite for good control is the establishment of a good connection between the temperature control application and the constant temperature equipment.

- Use short hoses with a large cross section to reduce the flow resistance.
- Select the thinnest possible heat transfer liquid (viscosity below 30 mm²/s) with the highest possible heating capacity. Ranking descending according to heat capacity: Water, water/monoethylene glycol mixture, oils, fluorinatedTM.
- Set pump or bypass so that the volume flow of the heat transfer liquid is as high as possible.

Effects of viscosity on the heat transfer liquid

A control that is stable at low temperatures will usually be stable at high temperatures. Conversely, if a system is just about stable at high temperatures, it will most probably be unstable at lower temperatures, i.e. vibrate.

The viscosity of the heat transfer liquid changes drastically with the temperature. At low temperatures, liquids are more viscous. The control quality is therefore generally poorer at low temperatures. For this reason, the control setting should be towards the lower end of the temperature range.

Example

If the temperature range of an application is between $-20 - 80\text{ }^{\circ}\text{C}$, a control setting of $-10 - 20\text{ }^{\circ}\text{C}$ is most suitable.

Influence of control parameters on the control action

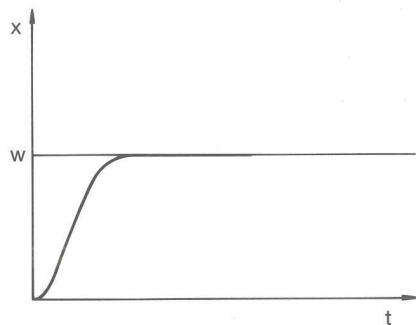
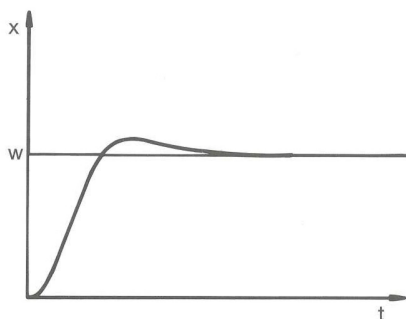
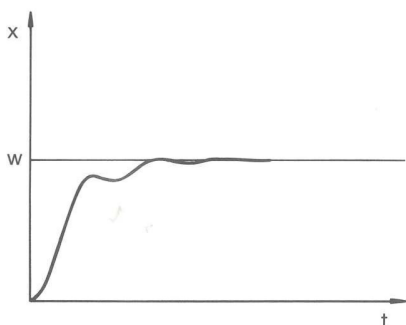

Fig. 65: Ideal setting



If the X_p parameter selected is too large, the actual value will reach the proportional range early and the P-component will be less than 100 % of the actuating signal. It takes longer to reach the target value and as a result, the simultaneously integrated I-component has more time to establish its actuating signal component. Once the target value is reached, the excessive addition of the I-component causes the value to overshoot the target value. If proportional range X_p is reduced, the P-component remains at 100 % for longer. Consequently, the actual value approaches the target value more quickly and the I-component has less time to integrate the system deviation. The overshoot is reduced.

Fig. 66: Control parameter X_p too large



If the proportional range selected is too small, the P-component of the actuating signal remains at 100 % for a long time. This value decreases even faster within the proportional range, i.e. the actuating signal decreases rapidly and the progress of the actual value towards the target value comes almost to a complete stop. The I-component, which only becomes effective now, causes the actual value to move slowly towards the target value.

Fig. 67: Control parameter X_p too small

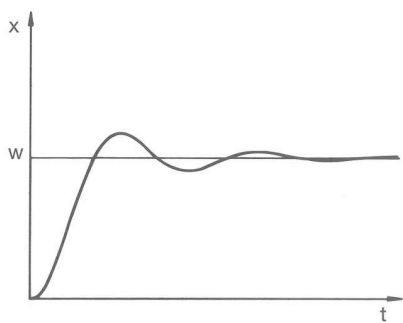

Fig. 68: Control parameters T_n and T_v too small

In the case shown here, the preset I component is too large (parameter T_n too small, T_n must be increased). The I-component integrates the control deviation until it becomes 0. If integration proceeds too rapidly, the actuating signal, i.e. the output signal of the controller, is too large. As a result, the actual value fluctuates (fading) around the target value. The hold-back time (parameter T_v) should be adapted using the formula: $T_v = T_n \times 0.75$.

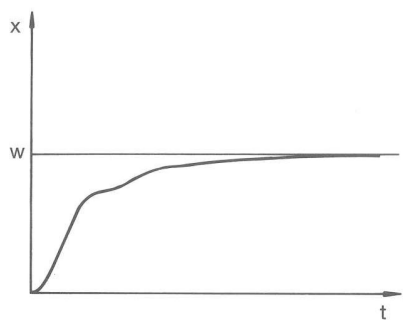

Fig. 69: Control parameters T_n and T_v too large

The actual value increases relatively sharply towards the specified target value. The proportional area settings seem to be correct. If the control deviation becomes smaller, the actual value approaches the target value much more slowly. The integration component (I-component) must compensate for the drastic reduction of the proportional component (P-component). In this case, the I-component is integrated too slowly. The parameter T_n , which specifies the integration interval, must therefore be reduced. The hold-back time (parameter T_v) should be adapted using the formula: $T_v = T_n \times 0.75$.

6.20.2 Overview of internal control parameters

The internal control compares the set temperature with the outflow temperature and calculates the actuating signal, i.e. the measurement used for heating or cooling.

Table 38: The following control parameters can be adapted for internal control:

Characteristics	Designation	Unit
X_p	Proportional range	K
T_n	Adjustment time	s
T_v	Hold-back time	s
T_d	Attenuation time	s



If T_v manual/auto is set to auto, T_v and T_d cannot be modified. In this case, they are derived with fixed factors of T_n .



The temperature limits T_{ih} and T_{il} also have an effect on the control.

6.20.3 Overview of external control parameters

- External control consists of a master controller (external controller) and a slave controller (internal controller). The temperature of the application to be temperature controlled is also required. In general this is determined with an external “Pt100 sensor”.
- The master controller compares the set temperature with the external temperature (application temperature) and, from these temperatures, calculates the set temperature (set_internal) for the slave controller (internal controller).
- The slave controller compares the set temperature (set_internal) with the outflow temperature and calculates the actuating signal, i.e. the measurement used for heating or cooling.

Table 39: The following control parameters can be adapted on the master controller (external controller):

Characteristics	Designation	Unit
K _{pe}	Amplification factor	-
T _{ne}	Adjustment time	s
T _{ve}	Hold-back time	s
T _{de}	Attenuation time	s
Prop_E	Proportional range	K

Table 40: The following control parameters can be adapted on the slave controller (internal controller):

Characteristics	Designation	Unit
X _{pf}	Proportional range	K



If T_v manual/auto is set to auto, T_v and T_{de} cannot be modified. In this case, they are derived with fixed factors of T_{ne}.



Furthermore, the following parameters can influence the external control:

- *Temperature limits: T_{il} and T_{ih}*
- *Controller output limit: Heating power and cooling power*
- *Correction limitation*

Correction limitation

If a temperature jump is specified via set temperature T_{set}, the control may set an outflow temperature which is considerably higher (e.g. 50 K, possible problem with enamel reactors) than the temperature T_{ext} required in the external application. Therefore, there is a correction limitation that specifies the maximum permitted deviation between the temperature at the pump connection pressure side T_{int} and the temperature at the external application T_{ext}.

1. Press the [Enter key] to open the menu.
2. Select the menu items → *Setup* → *Control* → *Correction limit..*
 - ▶ An entry window opens for the numerical value.
3. Enter the value.
4. Confirm the new value with the [Enter key].
 - ▶ The new value has been accepted.

6.20.4 Activate control variable

If the device is to be controlled to the internal control variable or an external control variable, you must set it accordingly. When setting, the old control variable with its set values is automatically deactivated. Only one control variable can be actively selected.

List of the possible control variables

- [Intern Pt1000]
- [Extern Pt100]
- [Extern analog]
- [Extern serial]
- [Extern USB]
- [Extern Ethernet]
- [Extern EtherCAT]
- [Extern Pt100-2]

Personnel: ■ Operating personnel

1. Press the Enter key to open the menu.
2. Select the menu items → *Setup* → *Control* → *Contr. Variable.*
 - ▶ The active control variable is marked with a checkmark.
3. Scroll to another control variable and select it with the Enter key.
 - ▶ The new control variable is valid with immediate effect.

6.20.5 Change control parameters



Fig. 70: Change control parameters

Personnel: Specialized personnel



Press the [ESC] soft key to return to the previous display without making any changes.

1. Press the Enter key to open the menu.
2. Select the menu items → *Settings* → *Control* → *Control parameters*.
 - ▶ If an **external** control variable is active, the external control parameter is shown on the display.
 - If the control variable **internal** is active, the internal control parameter is displayed on the display.
3. Scroll to another control parameter and select it with the Enter key.
 - ▶ An entry window opens. You can now change the numerical value. The displayed values *Max:* and *Min:* specify the limits for the value entry.
4. Press [OK] to confirm the new value.
 - ▶ The new value is active.

Enable control parameters for processing

- With *Tv manual/auto* you can define whether the control parameter *Tv* and *Td* or *Tve*, *Tde* and *Prop_E* are set manually or automatically. If the automatic setting is enabled, these control parameters are displayed with a lock and cannot be selected.
- To be able to set these control parameters manually, change the control parameter *Tv manual/auto* to manual setting.

6.21 Operator and viewer

Definition

Master - Operating unit on the LAUDA device

Command - Command Touch remote control (optional accessory with its own operating manual)

Operator - has read privileges and write privileges

Viewer - has read privileges only

The following operating units and interfaces are viewed:

- Master
- Command (optional accessory)
- Web server
- Control station/PC
 - connected to the constant temperature equipment via Ethernet interface, RS 232/485 interface (optional accessory), Profibus interface (optional accessory) or EtherCAT interface (optional accessory)
- Analog interface (optional accessory)
- Contact interface (optional accessory)



Allowing access to the device via the network

If you wish to have digital access to the device from the outside, this must be set in the device software beforehand.

Allowing access to the device

1. Press the [Enter key] to open the menu.
2. Select the menu items → *Setup* → *Basic setup* → *Ethernet* → *PC control* or → *Web server*.
 - ▶ The options [off] and [on] appear on the display.
3. Select the [on] option and press the Enter key to confirm.
 - ▶ A check mark is set. The entry has been accepted.

Range of functions of the operating units

- The full range of functions is available via the Master without restriction.
- Operation via the Command is reduced by the following functions:
 - Entry of Tmax
 - Selection of the heat transfer liquid
- Operation via the Web server is reduced by the following functions:
 - Entry of Tmax
 - Selection of the heat transfer liquid
 - Safety functions which require user presence at the device (e.g. menus for filling and draining)
- The control station is limited by the functionality of the interface and its protocol (command set).
- The analog interface and contact interface are restricted by their functionality and protocol.

Operator and viewer

Applies equally to Master, Command, Web server and Control station via

- Operator, once at maximum
 - The operator has all setting options available, both reading and writing, if included in the range of functions of the operating unit.
- Viewer, multiple times possible, only read privileges
 - All menus are accessible to the viewer, but no settings which change the function of the device can be made. Exceptions are entries which are necessary to log in as Operator.

The Master has Operator privileges in the set delivery condition.

If a user logs in via Web server or connects the Command operating unit, the Web server or Command has Viewer privileges.

An Operator is logged in and another operating unit requests Operator privileges (). The first Operator becomes a Viewer after this Operator requests Operator privileges.

If an Operator is downgraded to Viewer, a pop-up window appears with a corresponding message.

The Master automatically becomes an Operator if a detachable control element with Operator privileges is removed.

Exception: A Command Touch with restricted user privileges. In this case, an error is first generated by the constant temperature equipment. The Master becomes the Operator again after it has been restarted (without Command).

Control station

The connection to the control station is actively monitored in the set delivery condition. If no command is received by the device via Ethernet for more than 15 seconds, an interruption of communication is detected. If connection to the control station is interrupted, the constant temperature equipment reacts according to the configuration ↪ Chapter 6.24 “Safe Mode safety fittings” on page 127.

The timeout can be set from one to 99 seconds. Use the command [OUT_SP_08_XX] via the interface for this purpose.

The function can also be executed for the Ethernet interface via the → Setup → Basic setup → Ethernet → Services → PC control → PC Timeout menu. This must be set before the start of communication. If the monitoring of the control station is active, the Operator privileges are owned exclusively by the control station.

Neither Master, Command nor Web server can obtain Operator privileges. Operation on the constant temperature equipment is therefore locked. If a timeout occurs during monitoring, the Operator privileges can be automatically transferred to the constant temperature equipment.

A timeout value of 0 must be set to deactivate the monitoring of the connection. The constant temperature equipment can be operated from the control station/PC or on the constant temperature equipment itself. The Operator privileges can be obtained on an alternating basis. In this case, there is no monitoring of the communication and a connection interruption is not detected.



The control station obtains Operator privileges for each write command of the control station, provided that the Operator privileges are not locked by another control element. If the control station sends write commands very frequently, operation can be made more difficult for another control element.

Cold start

The Master returns to the previous login level after the device has been switched off and on again. The same applies to the Command control element and the Web server.

An exception to this is the situation where the operating unit which last requested the Operator privileges is not connected. In this case, the Operator privileges automatically return to the Master when the device is switched on.

Status display



If an operating unit has Viewer privileges, a lock symbol is displayed instead of the right-hand softkey or the Start/Stop button:

- The right-hand softkey with the Start/Stop assignment is replaced by the assignment with the lock symbol in the Master.
- The Start/Stop button is replaced by the lock symbol in the Command.
- The Start/Stop button is replaced by the lock symbol in the Web server.
- When operation is carried out using a control station, it is the responsibility of the user (customer) to display the status.

Requesting Operator privileges



Fig. 71: Operation on the device is locked

Locked Operator privileges

Operator privileges are requested by selecting the lock symbol:

- Press the right-hand soft key on the Master operating unit. A pop-up window appears with the query Yes/No.
- Press and hold down the Lock button on the Command remote control longer (> 0.5 s). A pop-up window appears with the query Yes/No.
- Click the Lock button in the Web server. A pop-up window appears with the query Yes/No.

Description:

Each operating unit with Operator privileges can disable the Operator privileges for other operating units/control stations (**lock**). In this case, no other operating unit/control station can obtain Operator privileges and it therefore remains a Viewer.

Locking of the Operator privileges in Command Touch:

- **User privileges** in addition to the Operator privileges and Viewer privileges are specifically available only in the Command Touch (see Command Touch operating manual).
If user privileges have been assigned/restricted via the Command operating unit (in the User configuration menu), all other operating units or the control station/PC become the viewer. Neither other operating units nor the control station can obtain Operator privileges. If an attempt is made to obtain Operator privileges, a message appears.
If a Command with restricted user privileges is disconnected from the constant temperature equipment, an error message is generated and the constant temperature equipment stops. The user must switch the device off and on again. The Master operating unit automatically becomes the Operator.

Locking of the Operator privileges in the control station

- If the monitoring of the control station is active, the Operator privileges are locked/owned exclusively by the control station.
No operating units can obtain Operator privileges. If an attempt is made to obtain Operator privileges, a message appears.
If the control station drops out, the constant temperature equipment is switched off and switched on again, an alarm is triggered or the control station monitoring is deactivated. Exclusive ownership is withdrawn from the control station.

Locking of the Operator privileges in the Master

- If a Safe Mode is triggered, the Operator privileges are transferred to the Master and locked/owned exclusively there. If the Safe Mode is deactivated, the exclusive ownership is withdrawn from the Master.

6.22 Web server LAUDA Command

The embedded Web server

The LAUDA device is equipped with an integrated Web server. The Web server is used to visualize device-internal and process-relevant data such as temperature, pressure and flow rate. The scope of the information displayed depends on the device, device type and installed accessories.

You can use the following software to access the Web server:

- **LAUDA Command app:**
Available in the app stores for mobile devices based on iOS and Android and in the Windows Store for Windows-based PC systems. The LAUDA Command app can also be downloaded from the LAUDA homepage for Windows-based PC systems. Open the LAUDA homepage, tap → *Services* → *Download center*. In the Download center, chose the [Software] option in the [Document type] drop-down list.
- **Web browser:**
Connection to the LAUDA device via a browser.

Requirements

- The LAUDA device and the PC/control station must be able to communicate with one another via a suitable network connection. The network settings can either be set automatically (*DHCP on*) or manually (*DHCP off*) on the device ↪ Chapter 4.7.2 “Configuring the Ethernet interface” on page 41.



Connection to the device via the LAUDA Command App

LAUDA recommends using the LAUDA Command app. If you use this app, state-of-the-art security mechanisms which offer a very high level of security against digital threats are automatically put in place. In addition to this, the App has an integrated search service for LAUDA devices in the local network, so that manual entry of a host name or IP address is no longer necessary.

Table of protocols used in the ISO/OSI model

Layers	Protocols
7 Application	HTTPs, DNS, DHCP server, Auto-IP, TLS, mDNS
6 Presentation	
5 Session	
4 Transport	TCP, UDP
3 Network	IP
2 Data link	Physical network
1 Physical layer	

Operating the device with the app

You are using the LAUDA Command app. This automatically searches for existing devices in the network. The devices found are displayed in a list. Select the required device. Connection to the device is established. If a connection to a device was established before closing the App, connection to this device is established when the App is started again.

Security with the web browser

The LAUDA device can be accessed with a web browser if users cannot use the LAUDA Command app for technical reasons or IT guidelines prohibit this. You must install the LAUDA CA certificates (Root CA, Device CA) to obtain a high level of security when using a web browser.

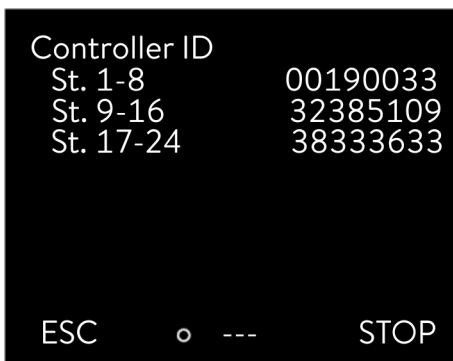

Fig. 72: Controller ID

You must carry out the following before using a web browser:

1. Download the CA certificates from the LAUDA homepage before connecting for the first time.
Open the LAUDA homepage, tap → *Services* → *Download center*.
2. In the Download center, chose the [Certificate] option in the [Document type] drop-down list.
 - ▶ A list of the certificates appears.
3. Tap the relevant certificate.
 - ▶ The download starts and a zip file is downloaded.
4. Install the certificates on all end devices which will be used later to access the LAUDA device.
5. Confirm the prompt inquiring whether you trust the LAUDA certificates with [Yes].
6. Compare the Common Name of the device certificate with the Controller ID of your LAUDA device during the initial connection setup.
The number can be displayed in the device menu → *Device Status* → *Controller ID*.
 - ▶ The 24-character identification number is displayed. This can consist of the numbers 0-9 and the letters A-F. This is shown on the display in three number blocks (digits 1-8, 9-16 and 17-24).
7. Confirm the connection.

Operating the device via the Web server

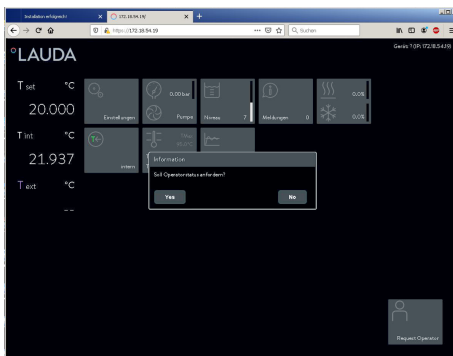

Fig. 73: Web server in the browser window

Operation of the LAUDA devices via the web server is carried out in the same way as operation via the operating unit on the device. If required, please refer to the respective descriptions of operation provided in this operating manual.

Operation of the device via the LAUDA Command App is very similar to the Command Touch remote control, whose operating instructions can be downloaded from our homepage. Open the LAUDA homepage, tap → *Services* → *Download center*. In the Download center, chose the [PRO] option in the [Product line] drop-down list.

You need the IP address or the serial number of the constant temperature equipment when you use the web browser. Enter the IP address or the serial number in the address line of the browser. Connection to the device is established.

Viewing the IP address

Select the menu items → *Setup* → *Basic setup* → *Ethernet* → *LAN configuration* → *Local IP address*.

Viewing the serial number

Select the menu items → *Device Status* → *Serial numbers*.

Cookies

Cookies must be activated if you use a web browser. The device creates a cookie with a connection-specific token which is generated during the initial mutual authentication. This information is lost if the cookie is rejected or deleted. Authentication must then be repeated the next time a connection is established.

Two-Factor Authentication (2FA) for increased security

Contact your network administrator if you require further assistance in implementing secure access.

Two-Factor Authentication is an authentication using a combination of two different and independent paths. The user is checked by the remote station and the remote station is checked by the user.

In the case of LAUDA, a user with automatically generated access data is created in the constant temperature equipment during the 2FA. The access data is stored in the App in the form of a token and as a cookie in the web browser. The token is valid for 6 months. In addition to this, all registered users (tokens) can be deleted via the Master on the constant temperature equipment. The user must repeat the 2FA in these cases.

The 2FA must be performed:

- At the first connection.
- When the token is no longer valid.
- When the cookie is no longer valid.
- If the cookie has been deleted in the browser or has not been saved.

The user is automatically prompted by the App or the web browser if a 2FA is necessary. A 6-digit one-time password is shown on the display of the device during 2FA. This is valid for 5 minutes.

Type the code displayed in the Web client and confirm your entry. The connection is continued if authentication is successful. If an error occurs, check whether your entry was correct.

6.23 LAUDA.LIVE Cloud Service



Fig. 74: Home window with cloud in the status bar

The LAUDA Integral IN enables the communication of device data to the cloud-based service LAUDA.LIVE. The service provides various optional features and offers, such as remote maintenance.

Please contact LAUDA or visit our website for detailed information about LAUDA.LIVE and its services.

To implement the LAUDA.LIVE service, device data is exchanged with the LAUDA.LIVE cloud via an encrypted connection, enabling the LAUDA service to remotely maintain the constant temperature equipment.

Requirements

- The LAUDA Integral IN has direct Internet access to LAUDA.LIVE via the Ethernet interface. It may be necessary to adjust the network settings and the local network conditions ↪ Chapter 4.7.2 “Configuring the Ethernet interface” on page 41.
Note: The constant temperature equipment uses a dynamic IP address via DHCP by default. No further network settings are necessary provided that this is supported in the local network and Internet access is enabled.
- Users who cannot provide the constant temperature equipment with Internet/LAUDA.LIVE access via their local network for technical reasons or whose IT policies prohibit this can use a LAUDA wireless gateway as an alternative (please contact LAUDA for further information).



LAUDA.LIVE access and data transmission are disabled by default.

Allowing access to the LAUDA.LIVE cloud



Fig. 75: Services

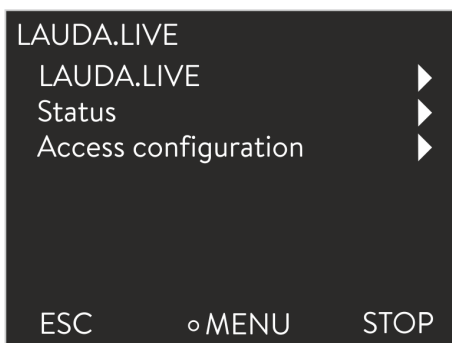

Fig. 76: LAUDA.LIVE menu

1. Press the Enter key to open the menu.
2. Select the menu items → *Setup* → *Basic setup* → *Ethernet* → *Services* → *LAUDA live* → *LAUDA live [off/on]*.
 - ▶ The options [off] and [on] appear on the display.
3. Select the [on] option and press the Enter key to confirm.
 - ▶ The entry has been accepted.

After switching on, the constant temperature equipment is registered and authenticated via an encrypted TLS connection and using a device-specific X.509 certificate in LAUDA.LIVE. For security reasons, the connection can only be initiated by the constant temperature equipment. A successful connection to LAUDA.LIVE is indicated in the same menu item under [Status]:

connected - currently connected to LAUDA.LIVE

connecting - connecting to LAUDA.LIVE

off - switch off LAUDA.LIVE



Fig. 77: Status bar with cloud

If a connection to LAUDA.LIVE already exists, a cloud appears in the status bar of the home window.

Since LAUDA provides the user with full control over the data to be transferred, device data is not transferred until LAUDA.LIVE access has been configured.

Configuring LAUDA.LIVE access

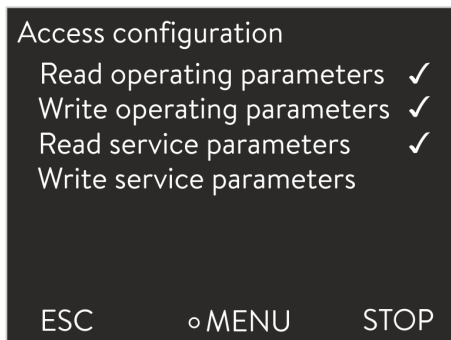

Fig. 78: Access configuration

1. Press the Enter key to open the menu.
2. Select the menu items *Setup* → *Basic setup* → *Ethernet* → *Services* → *LAUDA live* → *Access configuration*.
 - ▶ The following options appear on the display:
3. Select the desired option and press the Enter key to confirm.
 - ▶ A check mark is set. The entry has been accepted and the relevant option is selected.



The Access Configuration menu enables the user to independently define the data that can be transferred: [Op. param. readable] and/or [Service prm. readable].

In Access Configuration, a distinction is made between operating parameters (such as setpoint/actual temperatures, language, control parameters) and service parameters. The operating parameters are parameters that are displayed on the device display for the user and can be modified by the user. In contrast, the service parameters are only available to the LAUDA Service.



The user can modify parameters in the constant temperature equipment from the cloud using the [Op. param. writable] and/or [Service prm. writable] commands.

In addition to measures provided in LAUDA.LIVE for authorizing access and changing device data, e.g. 2-factor authentication, the device-side access configuration is used by the user for basic restriction/control of the LAUDA.LIVE services.

6.24 Safe Mode safety fittings

Aim of the Safe Mode

Safe Mode enables the user to determine an emergency operating mode for the constant temperature equipment and application in advance. In the event of faults in the process (e.g. failure of the communication with the control station), it is possible to switch to this safe operating mode quickly and easily.

The constant temperature equipment remains in this safe operating mode until Safe Mode is manually deactivated.

What happens when Safe Mode is **activated**?

- The parameters configured in Safe Mode are set.
- A warning *103 Safe Mode* appears on the display (home window).
- The parameters governed by Safe Mode cannot be changed.
- Any active programmer is stopped.
- The "Set point offset" function is switched off.
- The constant temperature equipment is automatically assigned the operator privileges. Operator privileges cannot be transferred to another control element while Safe Mode is active.

Which events lead to the **activation** of Safe Mode?

- communication with the control station being interrupted
- manually by the user

- via a command over an interface module ↗ Table 43 “Interface module and interface commands” on page 130
- by alarms ↗ Table 44 “Alarms that can trigger Safe Mode” on page 130

How does an alarm affect Safe Mode?

- Not all alarms trigger Safe Mode.
- Some alarms ignore the control variable setting in the Safe Mode menu.

What indicates that Safe Mode is **activated**?

- In the device display (Home window).
- Via the warning “103 Safe Mode active”
- Via the error in the interface command ↗ Chapter 4.7.7 “Error messages” on page 57.

What happens when Safe Mode is **triggered** by an alarm?

- The *alarm* is displayed.
- Safe Mode is activated.
- Safe Mode cannot be deactivated until the alarm has been acknowledged.



*Safe Mode can only be activated if the function of Safe Mode was previously **switched on** in the menu.*

Automatic activation of Safe Mode when the connection to the control station is interrupted

To activate Safe Mode when the connection is interrupted, switch on the Safe Mode function via the menu. Then configure the Safe Mode parameters. In addition, activate the control station monitoring function. Once control station monitoring has been switched on, the constant temperature equipment expects regular activity from the control station.

The control station must send a command to the constant temperature equipment periodically. The user must define the time the system waits before reporting a communication fault. If the control station does not issue a command within the specified time, Safe Mode is activated.



The device triggers Alarm 22 if the Safe Mode function is switched off ↗ Table 45 “Constant temperature equipment alarms” on page 144.

Acknowledging / deactivating an active Safe Mode

If Safe Mode has been activated, the operator can switch off Safe Mode in the associated menu. The parameters set by Safe Mode will be retained after Safe Mode is deactivated. The programmer is not continued automatically. If the “Set point offset” function is required, it must be activated manually.

Compatibility

The Safe Mode function cannot be used together with the EtherCAT module. The Safe Mode function is switched off and locked when the EtherCAT module is used.



If an alarm has activated Safe Mode, the following sequence must be observed:

- Acknowledge the alarm on the constant temperature equipment
- Switch off Safe Mode in the software of the constant temperature equipment. It is not possible to switch off using an interface command.
- Optional: Switch on Safe Mode again

Safe Mode menu

1. Press the [Enter key] to open the menu.
2. Select the → *Safe Mode* menu item and confirm the entry.
 - ▶ The submenu opens.

Table 41: Settings in the *Safe Mode* menu

Menu items in the Safe Mode menu	Description
Switch on/off of the Safe Mode function Function <input type="checkbox"/> off <input type="checkbox"/> on	Here you can switch the Safe Mode function on or off (factory setting). Select one of the following options: <input type="checkbox"/> <i>off</i> : Safe Mode is switched off. <input type="checkbox"/> <i>on</i> : Safe Mode is switched on. <input type="checkbox"/> Only when the Safe Mode function is switched on do the following menu items appear: <ul style="list-style-type: none"> ● Start ● Configuration
Manual activation of the Safe Mode function Start <input type="checkbox"/> off <input type="checkbox"/> on	Manual activation of the Safe Mode function: <input type="checkbox"/> Option <i>off</i> : Safe Mode is not activated. <input type="checkbox"/> Option <i>on</i> : Safe Mode is activated.

Menu items in the Safe Mode menu	Description
Deactivation of Safe Mode Stop <input type="checkbox"/> No <input type="checkbox"/> Yes	<ul style="list-style-type: none"> ■ Stop only appears after Safe Mode has been activated. ■ Safe Mode can only be deactivated if there are no pending alarms.
Configuration	In this submenu, you set the parameters that the device will continue to use when Safe Mode is activated ↪ Table 42 “Settings in the <i>Configuration</i> menu” on page 130.

Table 42: Settings in the *Configuration* menu

Menu items in the Configuration menu	Description of the options, actions with Safe Mode activated
<i>Setpoint change</i> This menu item is hidden when Safe Mode is activated.	Select one of the following options: <ul style="list-style-type: none"> ■ <i>Setpoint change</i>: When Safe Mode is activated, the device adjusts to the new setpoint previously set in the <i>Setpoint</i> menu. ■ <i>unchanged</i>: If Safe Mode is activated, the device retains the setpoint that it was previously using.
<i>Setpoint</i>	Here you enter the setpoint T_{set} that the device will continue to use after Safe Mode is activated. This value is stored in the Safe Mode parameters.
<i>Control</i>	Select one of the following options: <ul style="list-style-type: none"> ■ Option <i>unchanged</i>: If Safe Mode is triggered, the device retains the control variable that it was previously using. ■ Option <i>Internal Pt1000</i>: When Safe Mode is triggered, the device switches to the internal Pt1000 control variable.

Table 43: Interface module and interface commands

Interface	Interface command	ID	Description
Ethernet interface	OUT_MODE_06.1	72	The interface command activates Safe Mode. Activation is not possible if there is an error.
RS 232/485 interface	OUT_MODE_06.1	72	The interface command activates Safe Mode.

Table 44: Alarms that can trigger Safe Mode

Alarm	Description	Description of action
Alarm 9 External actual value is not available	Temperature value is not transmitted from the external sensor.	The settings of the temperature setpoint are adopted from Safe Mode <i>Configuration</i> menu. The control variable is switched automatically to internal.
Alarm 12 Current interface 1, interruption	Interruption to the analog module	The settings of the temperature setpoint and control variable are adopted from the Safe Mode <i>Configuration</i> menu.

Alarm	Description	Description of action
Alarm 13 Current interface 2, interruption	Interruption to the analog module	
Alarm 15 Fault at the digital input	Fault on the digital input/switching contact	
Alarm 16 Refilling has failed	Heat transfer liquid level is too low.	

6.25 Importing and exporting data

6.25.1 Importing data

Importing data from a USB stick

You can import the following data from a USB stick:

- Control parameters
- Analog module config.
- Contact module config.

If you have previously exported the control parameters, analog module configuration or contact module configuration of a device to a USB stick, you can use the USB stick to transfer them to another device.

Personnel: ■ Operating personnel

1. Insert the USB stick in the USB host on the operating unit of the machine.
2. Press the Enter key to open the menu.
3. Select the → *Data export/import* → *Data import* menu items in the main menu.
 - ▶ The submenu opens.
4. Select one of the following options:
 - Control parameters
 - Analog module config.
 - Contact module config.
5. Start the import by pressing the Enter key [OK].
 - ▶ After successful import, the following message appears on the display:
Data import from the USB stick has been successfully completed.
6. Confirm the message by pressing the Enter key [OK].

6.25.2 Exporting data

Data can be exported from the LAUDA device to a USB stick.

The software creates the directory *LAUDA* on the USB stick with a subdirectory. The subdirectory is named after the serial number of the device, for example "S200000.014". All the exported files are stored in the subdirectory.

If new data is exported to the USB stick from the same device, new files are created with ascending numbering.

A different LAUDA device creates a subdirectory with its own serial number on the same USB stick in the directory *LAUDA*.

3. Select the → *Data export/import* → *Data export* menu items in the main menu.
 - ▶ The submenu opens.
4. Select one of the following options:
 - n [Temperature graphic]
 - n [Device status]
 - n [Device data]
 - n [Control parameters]
 - [Analog module config.]
 - [Contact module config.]
5. Start the export by pressing the Enter key [OK].

Messages appear on the display during the export:

 - Data export to USB stick started.
 - Data export to USB stick has been successfully completed.
Confirm the message by pressing the Enter key [OK] once the data export has been completed.



If the data export was not successful, the message "Data export to USB stick failed" appears on the display. Press [OK] to confirm.

Check that the USB stick was inserted correctly and that there is enough free memory space (at least 1 MB).

Start the data export again.

7 Maintenance

7.1 Warning notes for maintenance

 DANGER! Contact with live or moving parts	
Electric shock, impacts, cutting, crushing	<ul style="list-style-type: none"> ● The device must be disconnected from the mains power supply before any kind of maintenance is performed. ● Only skilled personnel are permitted to perform maintenance work.
 CAUTION! Contact with hot or cold device parts, accessories and heat transfer liquid	
Scalding, hot or cold burns	<ul style="list-style-type: none"> ● Allow device parts, accessories and heat transfer liquid to reach room temperature before touching.

Protective equipment:

- Safety glasses
- Protective gloves
- Protective work clothing

7.2 Maintenance intervals

Interval	Maintenance work
Before switching on the device	Check the power supply cable for damage.
After every filling or draining process	Check whether the sealing caps are fitted to the draining nozzles and tightened.
After filling for the first time after each transport operation, after changing the heat transfer liquid, once a month at the latest	Check the function of the low-level protection.
As required, once a month at the latest	Inspect the external hoses, tubing clips and screw connections for leaks and damage.
after changing the heat transfer liquid, once a month at the latest	Check the function of the overtemperature protection.
Monthly	Clean the filter screen (cooling water dirt trap) in water-cooled devices.
As required, every three months at the latest	On air-cooled devices, clean the air-cooled condenser.
quarterly (a shorter interval must be selected, depending on the water hardness and operating period)	Descale the cooling unit or cooling coil.

Interval	Maintenance work
as required, once every six months at the latest	Check the serviceability of the heat transfer liquid.
As required, once a year at the latest	Check the external condition of the device for damage and stability.
Annually	Check the quality of the cooling water (limit values ↪ Chapter 4.5 “Cooling water requirements” on page 37).
Recommended every five years	Check the function of the gas sensor, contact ↪ LAUDA Service for more information.
Every ten years at the latest	Replace the gas warning sensor at the end of its service life, contact ↪ LAUDA Service for more information.
twenty years	Replacement of safety-relevant electrical and electromechanical components by LAUDA Service, including the circuit breaker and power printed circuit board.

7.3 Cleaning the device

Please note:

- Only use water and detergent to clean the control element. Do not use acetone or solvent as these substances will permanently damage the plastic surfaces.
- Ensure that the device is decontaminated after coming into contact with hazardous materials.
- It is forbidden to use decontaminants or cleaning agents that may react with parts of the device or materials contained in those parts and potentially pose a **hazard**.
- We recommend using ethanol as a decontaminant. If you are unsure whether decontaminants or cleaning agents are compatible with parts of the device or the materials contained in those parts, please contact the LAUDA Service department.

7.4 Cleaning the air-cooled condenser

This section is relevant for:

- Air-cooled devices



WARNING!
Risk of mechanical damage to refrigerant circuit

Burns, fire

- Use suitable materials/tools to clean the condenser (e.g. soft brush, vacuum cleaner or compressed air).
- Only specialists trained in handling flammable refrigerants are permitted to open the casing.

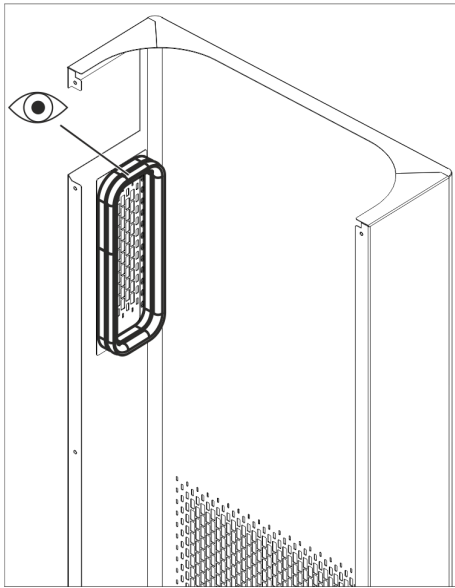

Fig. 80: Checking the gasket on the air socket



WARNING!
Incorrect handling when mounting the front housing plate

Fire

- Check the gasket on the air socket for damage (see Fig. 80). If you notice any damage, do not operate the device and contact LAUDA Service.
- Do not damage the gasket on the air socket during installation.



CAUTION!
Incorrect handling when removing and mounting the front housing panel

Physical overload

- Assign two people to remove and install the front housing panel.

Protective equipment: ■ Safety glasses
■ Protective gloves
■ Protective work clothing

With increasing operating time, the condenser becomes clogged with dust from the environment. This leads to a performance loss of cooling output.

1. Switch off the device.
 2. Pull out the mains plug.
 3. Remove the screws with which the front panel is screwed to the columns on both sides of the device. Remove only the screws for the lower front panel in the case of two-piece front panels.
- i** *The two marked screws must not be removed. They fix the plate of the module plug areas or the operating unit to the device.*
4. Remove the front panel by holding it with both hands, right and left, and pulling the front panel towards you. Remove the front panel slowly and carefully to avoid damage.
 5. Sweep the condenser with a hand brush or use a vacuum cleaner with brush attachment to clean the fins.
 6. Replace the front panel again with care.
 7. Fasten the front panel to both columns. Screw the screws on the right and left columns back in.
 8. You can switch the device back on.

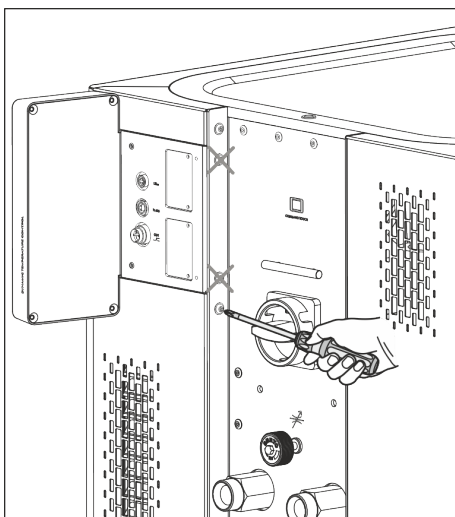

Fig. 81: Removing the front panel



Alternatively you can vacuum the dust with a vacuum cleaner through the ventilation openings on the front side.

7.5 Cooling water circuit maintenance

This section is relevant for:

- Water-cooled devices

Cleaning filter strainer

The cooling water circuit and filter strainer must be cleaned regularly to maintain full cooling output.

Personnel: ■ Operating personnel

Protective equipment: ■ Safety glasses

■ Protective gloves

■ Protective work clothing

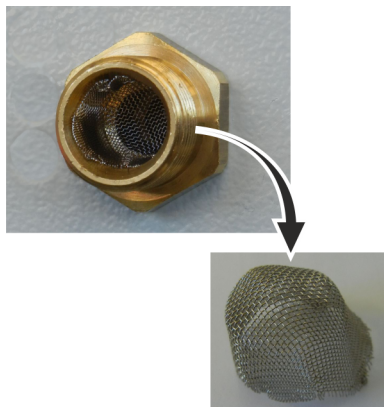

Fig. 82: Remove filter strainer

1. Switch machine off.
2. Shut down cooling water supply.
3. Unscrew the hose for the cooling water inlet from the device.
4. Remove the filter strainer from the water inlet. If necessary, use pointed pliers or large tweezers.
5. Clean the filter strainer.
6. Replace cleaned filter strainer and reconnect the hose.

Descaling the cooling water circuit

Required equipment for descaling with a pump (drum pump):

- a container with approx 20 liter volume
- a pump
- Hoses between container and pump and between pump and cooling water circuit
- Hose between cooling water circuit and container

Required equipment for descaling with a funnel:

- Two containers with 10 to 20 liter volume
- A funnel
- Hose between funnel and cooling water circuit. Place the funnel as high as possible, so that the device fills with descaler quickly
- Hose between cooling water circuit and container

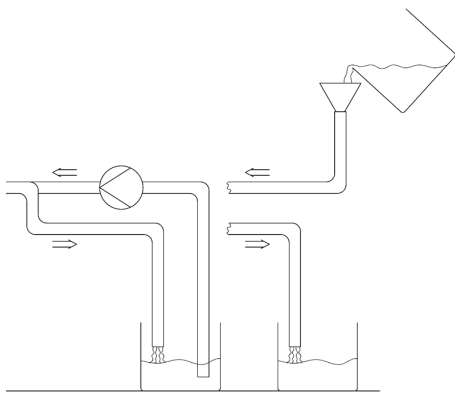

Fig. 83: Descaling

- Personnel: ■ Operating personnel
- Protective equipment: ■ Safety glasses
 ■ Protective gloves
 ■ Protective work clothing

1. Switch the device to standby
2. Press the Enter key to open the menu.
3. Select the menu items → *Fill mode* → *Water valve* → *open* on the operating unit.
 - ▶ The water valve opens.
4. Fill the device with descaler-water mixture via the hose on the cooling water inlet.
5. Recirculate the descaler/water mixture or refill continuously.
6. Leave the descaler-water mixture to work (see table below).
7. Flush the device thoroughly with clean water (see table below).
8. Drain cooling water circuit. Blow compressed air through the cooling water circuit.
9. Select the menu items → *Fill mode* → *Water valve* → *auto* (auto-matic) on the operating unit. This is the default setting.

Reaction time:	Continue pumping or refilling until the foaming reaction (usually at the beginning) has subsided. This usually takes 15 to 30 minutes.
Descaler:	Only permitted: LAUDA Decalcifier with article number LZB 126 (5 kg pack). You must always follow the safety instructions and the instructions for use on the packaging when handling the chemical!
Flushing:	Let at least 30 liters of clean water run through the device.

7.6 Checking the overtemperature protection

The device must switch off if the temperature of the heat transfer liquid exceeds the overtemperature switch-off points T_{max} and/or $T_{maxTank}$. The electronics system switches off the device components.



WARNING!
 A functional failure of the overtemperature protection is not detected

Burns, scalding, fire

- Perform regular checks of the T_{max} function and the T_{max_Tank} function according to the maintenance intervals.

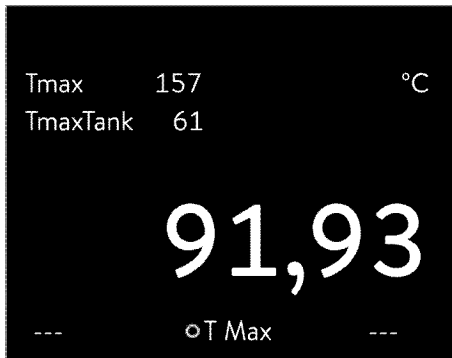

Fig. 84: Display Tmax



Fig. 85: Enter Tmax

1. Press and hold down the T_{\max} key ↵ Chapter 6.4 “Setting the over-temperature switch-off point Tmax” on page 87.
 - ▶ The values T_{\max} and $T_{\max\text{Tank}}$ appear on the display.
2. With the arrow keys select the T_{\max} value, while keeping the T_{\max} key pressed down.
3. Press the Enter key.
 - ▶ The entry window appears. The cursor flashes under the T_{\max} value.

4. Use the arrow keys to set a value that is a few °C above the set temperature T_{set} .



If you release the T_{\max} key the process is aborted.

5. Press [OK] to confirm the new value.
6. Press the [ANW.] softkey to confirm the new value.
 - ▶ The new value is active.
7. Now set the set temperature T_{set} higher than the overtemperature switch-off point T_{\max} . Press [OK] to confirm the set temperature.
 - ▶ The device heats up. The device switches off when the overtemperature switch-off point is exceeded. A fault is displayed.
8. Using the T_{\max} key, set the correct T_{\max} value again.
 - ▶ In the display the set T_{\max} value is displayed.
9. Delete the fault in the device menu.

7.7 Checking the low-level protection

An alarm signal sounds before the liquid level decreases so much that the heater is no longer covered completely with liquid. *Low level* appears on the display. The electronics system switches off the device components.



WARNING!
Contact with hot or cold heat transfer liquid

Scalding, cold burns

- Bring the heat transfer liquid to room temperature before draining.



WARNING!
Failure of the low-level protection is not detected

Burns, scalding, fire

- Carry out regular checks of the low-level protection.



An alarm must sound as soon as the minimum level is reached.

Protective equipment: ■ Safety glasses
■ Protective gloves
■ Protective work clothing

1. Switch on the device and the pump. Set the set temperature to room temperature.
2. Watch the level indication on the display.
3. Lower the liquid level in the device. For this purpose, allow the heat transfer liquid to flow out into a suitable container via the open drain nozzle.
 - ▶ The display shows that the heat transfer liquid is sinking.
If the fill level falls to level 2, a warning is issued on the display.
If the liquid falls to level 0, the device switches off and the *Alarm* message appears on the display.
4. Close the drain tap.
5. Top up the heat transfer liquid.
 - ▶ The liquid level in the display rises.
6. Delete the fault in the device menu.

7.8 Check the heat transfer liquid



WARNING!
Contact with hot/cold heat transfer liquid

Scalding, cold burns

- Bring the heat transfer liquid to room temperature for analysis.

This warning is only valid for flammable heat transfer liquids:

 WARNING! Heat transfer liquid wear (degradation, aging, (oxidation))	
	Fire
	<ul style="list-style-type: none"> The serviceability of the heat transfer liquid must be checked if necessary (e.g. if the operating mode is changed) but at every prescribed maintenance interval at the latest. Continued use of the heat transfer liquid is only permitted following successful testing.

This warning is only valid for -non-flammable heat transfer liquids:

 NOTICE! Wear, contamination, dilution of the heat transfer liquid	
	Device damage
	<ul style="list-style-type: none"> The serviceability of the heat transfer liquid must be checked if necessary (e.g. if the operating mode is changed) but at every prescribed maintenance interval at the latest. Continued use of the heat transfer liquid is only permitted if the check indicates this.

	<i>Wear of the heat transfer liquid</i>
	<ul style="list-style-type: none"> <i>Heat transfer liquid is subject to wear, such as cracking or aging (oxidation).</i> <i>The serviceability of the heat transfer liquid must be checked if necessary (e.g. if the operating mode is changed), at least every six months.</i> <i>Continued use of the heat transfer liquid is only permitted following successful testing.</i>

- Protective equipment:
- Safety glasses
 - Protective gloves
 - Protective work clothing

Where applicable, the following points should be considered when testing the heat transfer fluid:

Flash point

1. Impairment of the flash point, for example due to aging and oxidation, impurities and thermal stress.

Viscosity

2. Medium becomes tougher due to resinification caused by oxidation, for example.

Water content	<p>3. Boiling delay due to water content in thermal oil.</p> <p>Interruptions in the flow of the heat transfer liquid due to boiling of low-boiling and non-homogeneous liquids.</p> <p>For water/monoethylene glycol mixtures: The water content decreases during longer periods of operation at higher temperatures and the mixture becomes flammable.</p>
Boiling point	<p>4. Lowered boiling point due to cracking (splitting of C-C chains into hydrocarbons).</p>
Cloudiness	<p>5. Increase in deposits, suspended matter and particles due to thermal reactions and oxidation, for example.</p>
Color	<p>6. Medium turns darker, even black, due to oxidation, for example.</p>
Odor	<p>7. Smells rancid or burnt, for example.</p>
Application	<p>8. General deterioration in thermal performance.</p> <p>Reduction in the achievable temperature stability.</p>

8 Fault elimination and repair

8.1 Repair

 DANGER! Contact with live or moving parts
Electric shock
<ul style="list-style-type: none"> ● Before starting any service or repair work, switch off the device and pull out the mains plug. ● Only skilled personnel are permitted to perform service and repair work.

 DANGER! Incorrect handling
Explosion, burns, fire
<ul style="list-style-type: none"> ● Only certified specialists who are trained to handle flammable refrigerants are authorized to perform repair and disposal work. ● In order to avoid the risk of possible ignition due to incorrect maintenance or the installation of incorrect parts, only specialists certified by the manufacturer are authorized to carry out maintenance. ● Any components and parts must be replaced with identical parts.

8.2 Alarms, errors and warnings

All alarms, error messages and warnings triggered on the device appear in text form on the display.

Procedure in event of alarm

Alarms affect safety. The components of the device, such as the pump, switch off. The device emits a sound. Once the cause of the fault has been eliminated, the alarm can be canceled with the Enter key.

Refer to  Chapter 8.3 “Alarms” on page 144 for a list of alarms.

Procedure in event of warning

Warnings do not have a significant effect on safety. The device continues to operate. The device will make a continuous noise for a short period of time. Warnings are issued periodically. Once the cause of the fault has been eliminated, the warning can be canceled with the Enter key.

Procedure in event of error

If an error occurs, the device emits a sound.

If this happens, switch off the device at the mains switch. If the error occurs again after switching on the device, make a note of the error code and the corresponding description and contact the LAUDA Constant Temperature Equipment Service department. You will find the contact information here  Chapter 12.5 “Contact LAUDA” on page 156.



Errors are displayed with an appropriate description and an error code in the form of a consecutive number.

8.3 Alarms



Alarms are shown on all displays in use.

Table 45: Constant temperature equipment alarms

Alarm code	Message	Description	User action
1	Low-level pump	Pump detects a low level, pump speed too high	Refilling the heat transfer liquid
2	Low level	Float detects low level	Refilling the heat transfer liquid
3	Overtemperature	Overtemperature (bath temperature/outflow temperature > T _{max})	Allow the device to cool down to T < T _{max} ; adjust T _{max} , if necessary
4	Pump is blocked	Standstill of the pump	Switch off the device, check the viscosity
5	Command connection interrupted	Command Touch remote control withdrawn during operation.	Plug in the cable of the Command Touch remote control unit.
6	No water flow	No flow or insufficient flow in the cooling water circuit	Hose may be kinked/squashed
7	Cooling water	Cooling water too hot/no cooling water flow	Provide a supply of cooling water
8	---	Low level in expansion vessel	---
9	T ext Pt100	No actual value from the Pt100 module	Check the temperature probe
10	T ext analog	No actual value from the analog interface	Check the temperature probe
11	T ext serial	No actual value from the serial interface	Check the serial connection
12	Analog input 1	Analog module: Current interface 1, interruption.	Check the connection
13	Analog input 2	Analog module: Current interface 2, interruption.	Check the connection
14	High level	Float detects high level	Drain excess heat transfer liquid from the device. Caution: risk of burns
15	Digital input	Interference signal at the input of the contact module	(customer application)
16	Refilling	Heat transfer liquid level is too low	Refilling the heat transfer liquid

Alarm code	Message	Description	User action
19	Gauge pressure	Gage pressure in the outflow	Reduce/eliminate the hydraulic resistance in the hoses or/and in the consumer
20	Text Ethernet	No actual value from the Ethernet interface	Check the serial connection Check whether the control station specifies the actual temperature via the Ethernet interface
22	Communication interrupted	A.) Connection to the control station interrupted (PC controller) B.) Preset control station monitoring timeout exceeded (interface function "ID34 Security") C.) When Safe Mode function is activated: Preset control station monitoring timeout exceeded (interface function "ID34 Security")	A.) Check the cable connection B.) Check interface communication, adjust timeout, if necessary C.) Acknowledge Safe Mode, check interface communication, adjust timeout, if necessary, switch Safe Mode back on → "Automatic activation of Safe Mode when the connection to the control station is interrupted" on page 128
23	Text EtherCAT	No actual value from the EtherCAT interface	Check the serial connection
24	Overtemperature	Overtemperature in expansion vessel ($T > T_{maxTank}$) Overtemperature in devices with pressure overlay ($T > T_{max_Return}$)	Allow the device to cool down

Table 46: Flow Controller Alarms

Alarm code	Message	Description	User action
55	Flow meter timeout	Error in the LiBus cable connection	<ul style="list-style-type: none"> ■ Switch off the constant temperature equipment ■ Check the LiBus cable connection and restore if necessary ■ Switching the constant temperature equipment on

8.4 Troubleshooting

Before informing the LAUDA Service department, please check whether you can solve the problem with the following instructions.

Table 47: Process thermostat

Fault or message	Possible cause	Possible remedy
The device cools very slowly or not at all.	<ul style="list-style-type: none"> ■ Cooling unit is switched off ■ Controller output limit is active ■ Temperature limit T_{il} is too high ■ Condenser is contaminated 	<ul style="list-style-type: none"> ■ Switch on the cooling unit. ■ Switch off the controller output limit. ■ Reduce the temperature limit T_{il}.
The device heats only very slightly or not at all.	<ul style="list-style-type: none"> ■ Controller output limit is active ■ Temperature limit T_{ih} is too low. ■ The dynamic heating capacity restriction is active. ■ The maximum heating output is automatically reduced in the lower pump levels. ■ The maximum current consumption of the device is limited. 	<ul style="list-style-type: none"> ■ Switch off the controller output limit. ■ Increase the temperature limit. ■ Switch off the dynamic heating capacity restriction. ■ Increase the pump level. ■ Increase the current consumption.
Pump level cannot be set.	<ul style="list-style-type: none"> ■ Pressure control is active 	<ul style="list-style-type: none"> ■ Switch off pressure control (pressure control is switched off if set pressure = 0 bar).
Degassing functions poorly.	<ul style="list-style-type: none"> ■ Pressure control is active ■ Pump level is too high ■ Heating output is too high ■ Cooling unit is active ■ Heat transfer liquid is heavily contaminated ■ The filler nozzle is closed. 	<ul style="list-style-type: none"> ■ Switch off the pressure control. ■ Select a lower pump level. ■ Limit the heating output. ■ Switch off the cooling unit. ■ Change the heat transfer liquid. Empty the device completely and carry out internal cleaning of the device if required. ■ Remove the tank lid and place it loosely on the filler nozzle.
Cooling unit starts several times in quick succession	–	<ul style="list-style-type: none"> ■ Normal function (special start), no remedy necessary
The cooling unit is in operation for a few minutes, although no cooling is necessary.	–	<ul style="list-style-type: none"> ■ Normal function (protection function), no remedy necessary
Display: Low flow (cooling unit). (Flow in the evaporator area too low)	<ul style="list-style-type: none"> ■ Hydraulic circuit is blocked (closed valves, jammed hose, dirt, etc.). ■ The current pump level is too low ■ Hose cross-section too small ■ Cooling capacity is too high for the current flow rate 	<ul style="list-style-type: none"> ■ Eliminate the cause. ■ Select a higher pump level. ■ Increase the cross-section or install a bypass. ■ Limit the cooling capacity.

Fault or message	Possible cause	Possible remedy
Display: Low flow (heater) (Flow in the heater area too low).	<ul style="list-style-type: none"> ■ Hydraulic circuit is blocked (closed valves, jammed hose, dirt, etc.). ■ The current pump level is too low ■ The device is not sufficiently aerated or degassed ■ Hose cross-section too small ■ The heating output is too high for the current flow rate 	<ul style="list-style-type: none"> ■ Eliminate the cause. ■ Select a higher pump level. ■ Degas the device again. ■ Increase the cross-section or install a bypass. ■ Limit the heating output.
Display: Overtemperature protection	<ul style="list-style-type: none"> ■ The outflow temperature is higher than the overtemperature switch-off point. 	<ul style="list-style-type: none"> ■ Wait until the outflow temperature has cooled below the overtemperature switch-off point. ■ Set the overtemperature switch-off point higher than the outflow temperature, if permissible for the heat transfer liquid.
Display: Level very low (Impending low level in expansion vessel) Display: Low level (Low level in expansion vessel)	<ul style="list-style-type: none"> ■ A hose leak, connections or application. ■ Cooling or degassing may cause the liquid level to drop. ■ A leak in the constant temperature equipment. 	<ul style="list-style-type: none"> ■ If necessary, repair the leak and top up the missing heat transfer liquid. ■ If necessary, top up the missing heat transfer liquid. ■ If necessary, inform LAUDA Service ↗ Chapter 12.5 “Contact LAUDA” on page 156
Display: Level too high (Impending high level in expansion vessel). Display: Level too high (High level in expansion vessel).	<ul style="list-style-type: none"> ■ heating increases the volume ■ the heat transfer liquid has absorbed moisture from the ambient air 	<ul style="list-style-type: none"> ■ Drain the heat transfer liquid ■ Boil the heat transfer liquid, if possible or replace the heat transfer liquid.
Display: Pump blocked (Pump motor monitoring: overload, blockage).	<ul style="list-style-type: none"> ■ The viscosity of the heat transfer liquid is too high. ■ The pump is clogged. 	<ul style="list-style-type: none"> ■ Change to a different heat transfer liquid or increase the set temperature. ■ Notify LAUDA Service ↗ Chapter 12.5 “Contact LAUDA” on page 156
Display: Low level (pump) (Pump motor monitoring: idling).	<ul style="list-style-type: none"> ■ No heat transfer liquid in system. If this is the case, the level monitoring has failed. 	<ul style="list-style-type: none"> ■ Check whether the float in the expansion vessel is blocked by a foreign object. If not, notify the LAUDA Service ↗ Chapter 12.5 “Contact LAUDA” on page 156 department.
Display: Gauge pressure (Outflow pressure too high)	<ul style="list-style-type: none"> ■ Pump level is too high ■ When the pressure control is active, the setpoint pressure is too high. ■ The maximum pressure setting is too low. ■ 	<ul style="list-style-type: none"> ■ Select a lower pump level. ■ Reduce the setpoint pressure. ■ Increase the maximum pressure, but only if your application, hoses, etc. cannot be damaged.

Fault or message	Possible cause	Possible remedy
Display: Evaporator frozen	<ul style="list-style-type: none"> ■ Pump level too low. ■ Bypass not used. ■ Flow in the application too low. 	<ul style="list-style-type: none"> ■ Increase the pump level. ■ Open the manual bypass in the constant temperature equipment. ■ Increase the flow rate through the application by using a higher pump level or shorter hoses with larger diameters.
Unstable temperature control (Temperature fluctuates strongly)	<ul style="list-style-type: none"> ■ Pump level too low. ■ Bypass not used. ■ Incorrect control parameter setting. 	<ul style="list-style-type: none"> ■ Increase the pump level. ■ Open the manual bypass in the constant temperature equipment. ■ If necessary, increase the control parameters X_p and T_n. Initiate self adaptation on the device. ■ Increase the flow rate through the application. ■ Reduce the load.

9 Decommissioning

9.1 Information on decommissioning



NOTICE!

Cooling water circuit is damaged by frost expansion

Device damage, environmental impact

- When decommissioning the device or if there is a risk of freezing, drain the cooling water circuit on the cooling unit. Use compressed air or an industrial vacuum cleaner (water-proof). Blow compressed air through the cooling water circuit.

Decommissioning

- Protective equipment:
- Safety glasses
 - Protective gloves
 - Protective work clothing

To avoid damage during storage, all liquids must be drained completely from the device.



For devices with a cooling water valve, the [Filling mode] menu contains a submenu with [Auto], [open] and [closed]. To drain the cooling water circuit, select [open].

1. Drain the heat transfer liquid from the device ↪ “Draining the device” on page 149.
2. On water-cooled devices, drain the cooling water from the cooling water circuit ↪ Chapter 9.3 “Draining the cooling water circuit” on page 151.
3. Store the device, maintain the storage temperatures ↪ Chapter 13.1 “General” on page 157.

9.2 Drain the heat transfer liquid and clean the thermostatic circuit

Draining the device



Do not drain the heat transfer liquid in a hot state above 90 °C or in a cold state below 0 °C!



Observe the regulations for the disposal of used heat transfer liquid. ↪ Chapter 4.4 “LAUDA heat transfer liquids” on page 35, ↪ Chapter 10.4 “Disposing of heat transfer liquid and liquids” on page 153

- Protective equipment: ■ Safety glasses
 ■ Protective gloves
 ■ Protective work clothing

The drain taps and drain nozzles are located on the right hand side of all devices.

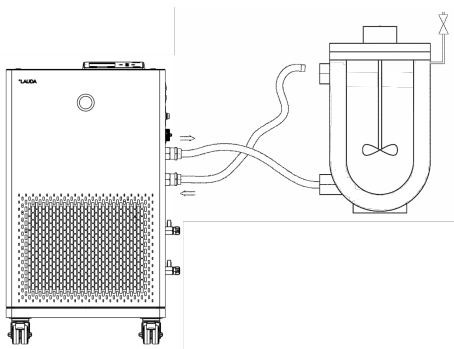



Fig. 86

1. Allow the device and heat transfer liquid to cool or warm up to room temperature.
2. Screw the hose nozzle with a union nut (EOA 078) onto the drain nozzle (3/8" exterior thread). There are two drain nozzles.
3. Insert a hose on the hose nozzle for draining. Place the hose in a suitable container to collect the heat transfer liquid.

 *It may be necessary to drain the device several times if the filling volume is high.*

4. Open the drain tap. To do this, turn the tap counterclockwise.
5. Allow the device to run empty.

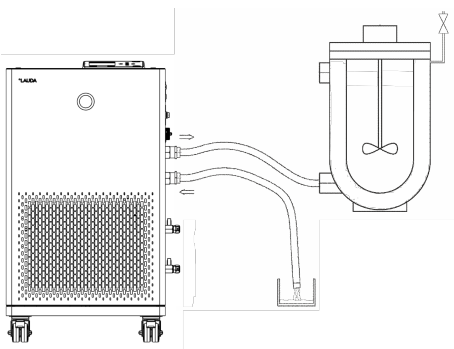

Fig. 87

6. After the device has run empty, remove the hoses from the external consumers. Drain the heat transfer liquid in the hoses into a suitable container.
7. After draining close the drain tap or taps.

Internal cleaning

After the heat transfer liquid has been drained, residues remain in the device. These residues must be removed to avoid deposits in the device during storage.

If new heat transfer liquid is added and the device is operated above the thermal load limit for the old heat transfer liquid, deposits can form, especially on the heaters. These coatings reduce the performance of the device and/or reduce the service life of the device.

- Protective equipment: ■ Safety glasses
 ■ Protective gloves
 ■ Protective work clothing

If necessary, clean or flush out the device (with new heat transfer liquid, for example).



WARNING!
Risk of damage to the evaporator

Fire

- Do not use water as a cleaning fluid.
- Select one of the fluids listed in ↗ Table 48 “Cleaning fluids” on page 151.

1. Connect a hose to the pump connectors (short circuit between the outflow connector and the return connector).
2. Fill the device with a suitable cleaning fluid. During this time, operate the device in fill mode.
3. Drain the device via the drain connector.
4. Check the cleaning fluid for dirt and the remains of old heat transfer liquid.
 - ▶ If you detect dirt in the cleaning fluid, repeat points 2 to 3. Otherwise continue with point 5.
5. Remove hose from the pump connector.
6. Dry the hydraulic circuit in the device with compressed air. To do this, carefully allow the compressed air to flow into the device alternately via the outflow and return connectors.



If the device has been cleaned with a highly oil-soluble liquid (e.g. ethanol), do not leave it dry for longer periods (1 day) or transport it, as the pump requires a minimum lubrication.

Table 48: Cleaning fluids

Suitable cleaning fluid	for heat transfer liquid
Ethanol (solvent) <i>It is essential to observe the relevant safety measures for handling ethanol!!</i>	Kryo 30
	Kryo 65
	Kryo 70 A
	Kryo 95
	Ultra 350

9.3 Draining the cooling water circuit

This section is relevant for:

- Water-cooled devices

To avoid damage during storage, the cooling water circuit on water-cooled devices must be drained completely.

Protective equipment: ■ Safety glasses
■ Protective gloves
■ Protective work clothing

The device is now in standby mode.

1. Shut down the cooling water supply.
2. Unscrew the hose for the cooling water inlet from the device.
3. Remove the filter strainer from the water inlet. If necessary, use pointed pliers or large tweezers.
4. Clean the filter strainer.
5. Press the Enter key to open the menu.
6. Select the menu items → *Fill mode* → *Water valve* → *open* on the operating unit.
 - ▶ The water valve opens.
7. Drain the cooling water circuit completely.
8. Select the menu items → *Fill mode* → *Water valve* → *auto* (auto-matic) on the operating unit. This is the default setting.
9. Place the cleaned filter screen back into the water inlet.

10 Disposal

10.1 Disposing of packaging

The following applies for EU member states: Disposal of the packaging must proceed according to regulation 94/62/EC.

10.2 Disposing of refrigerant



DANGER!
Uncontrolled leaking of refrigerant

Explosion, burns, fire

- Never dispose of a cooling circuit that is still pressurized.
- Only certified specialists who are trained in the handling of flammable refrigerants are permitted to perform disposal work.

Personnel: Certified specialist



The type and filling weight of the refrigerant are indicated on the type plate.

1. Always have any repair and disposal work carried out by a certified refrigeration technician.

10.3 Device disposal



The following applies for EU member states: The device must be disposed of according to Directive 2012/19/EU (WEEE Waste of Electrical and Electronic Equipment).

10.4 Disposing of heat transfer liquid and liquids

Information on the disposal of heat transfer liquid and other liquids (e.g. ethanol):

- Liquids must be disposed of in accordance with the official regulations.
- Refer to the relevant safety data sheet for the liquid for information on correct disposal.
The link to the LAUDA safety data sheets can be found in [↗](#) Chapter 4.4 “LAUDA heat transfer liquids” on page 35.
- Use the original containers of the liquids when transporting them for disposal.

11 Accessories

The following accessories are available for Integral IN devices.

Table 49: Interface modules

Accessories	Catalog number
Analog interface module	LRZ 912
Pt100 / LiBus interface module	LRZ 925
RS 232/485-interface module Advanced	LRZ 926
Contact interface module Advanced with one input and one output	LRZ 927
Contact interface module Advanced with three inputs and three outputs	LRZ 928
Profibus interface module Advanced	LRZ 929
EtherCAT interface module Advanced, M8 socket connection	LRZ 931
Profinet interface module Advanced	LRZ 932
CAN interface module Advanced	LRZ 933
OPC UA interface module Advanced	LRZ 934
Modbus TCP/IP module Advanced	LRZ 935

Table 50: Connecting plugs and cables

Accessories	Catalog number
External temperature probe with socket and shielded connection cable	ETP 059
Coupling connector, 6-pin for analog inputs/outputs	EQS 057
Connecting plug SUB-D, 9-pin	EQM 042
RS 232 cable (length: 2 m) for PC	EKS 037
RS 232 cable (length: 5 m) for PC	EKS 057
3-pin coupling connector for contact input	EQS 048
3-pin coupling socket for contact output	EQD 047

Accessories	Catalog number
Command Touch remote control	LRT 923
Flow controller FC 80 MID	L003217
Flow controller FC 80 C	L004110
Filling and draining unit (FD 50)	L003650, L004057, L004011, L004058

Please also refer to our accessory brochures for further accessories.

12 General

12.1 Copyright

This manual is protected by copyright and only meant for internal use by purchasers.

The relinquishment of this manual to third parties, copying in any way whatsoever – even in the form of excerpts – and the utilization and/or conveyance of its content are not allowed, except for internal purposes, without written approval from the manufacturer.

Violation of this may obligate the violator to the payment of damages. Other claims reserved.

We point out that the designations and brand names of the respective companies used in the manual are generally subject to trademark, brand and patent protection.

12.2 Technical changes

The manufacturer reserves the right to make technical modifications to the device.

12.3 Warranty conditions

LAUDA offers a standard 12 month manufacturer's warranty on Integral process thermostats from the date of purchase.

12.4 License texts

You can obtain the license texts for the software used in the device from the English version of our LAUDA website.

1. Enter the following into your browser's address line: <https://www.lauda.de/en/> and confirm your entry.
2. Click → *Services* → *Download center*.
3. In the Download center, chose the [English] option in the [Language] drop-down list.
 - ▶ A long list of files with multiple formats appears.
4. Now also filter the [Software] entry in the [Document type] drop-down list.
 - ▶ The list is now more clear.
5. Search for the following software files:
 - Lizenztexte_μTZ.txt
 - Lizenztexte_Qt.txt
 - GUF-Yocto-31.2-r8616-0.tar.zipClick on the relevant file line to start the download.
 - ▶ The file starts downloading.

12.5 Contact LAUDA

Contact the LAUDA Service department in the following cases:

- Troubleshooting
- Technical questions
- Ordering accessories and spare parts

Please contact our sales department for questions relating to your specific application.

Contact information

LAUDA Service

Phone: +49 (0)9343 503-350

Email: service@lauda.de

13 Technical data

13.1 General

Table 51: Common technical specifications

Specification	Value	Unit
Display type	TFT, white font on black background	---
Display size	3.5	Inches
Display resolution	320 x 240	Pixels
Setting resolution	0.01	°C
Display resolution	0.01	°C
Display accuracy, internal/outflow	±0.2	°C
Input	via eight keys	---
Installation and use	Indoors	---
Use up to a maximum height above sea level of	2,000	m
Air humidity	Maximum relative humidity 80% at temperatures up to 31 °C, linearly decreasing until 50% relative humidity at 40 °C	---
Mains voltage fluctuations	Permissible up to ±10% of the nominal voltage	---
Protection level (IP code) according to IEC 60529	IP 21	---
Degree of pollution according to EN 60664-1 / VDE 0110-1	Pollution degree 2 only <u>non-conductive</u> contamination, whereby temporary conductivity caused by condensation is occasionally expected	---
Protection class for electrical equipment DIN EN 61140 (VDE 0140-1)	1	---
Class division according to DIN 12876 All devices marked XT and XTW:	FL (suitable for combustible and non-combustible liquids)	---
Temperature range for storage of the device	5 – 43; For water-cooled devices, the condenser must be completely empty	°C
Temperature range for transport of the device	-20 – 43; For water-cooled devices, the condenser must be completely empty	°C
Ambient temperature range during operation	5 – 40	°C



The noise level of the various devices was measured according to the guidelines included in DIN EN ISO 11200 and the basic standards cited therein. The measured values correspond to the operating conditions that occur during typical device operation.

Installation location

- Minimum free room volume per kg of refrigerant according to DIN 378-1:
(For refrigerant quantity, see type plate or ↗ Chapter 13.4 “Refrigerant and filling weight” on page 162)

Table 52: Refrigerant and room volume

Refrigerant	Room volume per kg of refrigerant
R-290	132 m ³ /kg
R-1270	109 m ³ /kg

Example: Quantity of refrigerant 0.47 kg of propane (R-290)

Minimum room size = room volume per kg of refrigerant x quantity of refrigerant

$$\text{Minimum room size} = 132 \text{ m}^3/\text{kg} \times 0.47 \text{ kg} = 62.1 \text{ m}^3$$

- Note the minimum room volume. If the lower limit is exceeded, additional measures must be taken, such as installation in the machinery room or outdoors.
- There must be no ignition sources in the immediate vicinity of the constant temperature equipment.

Specific device data

Table 53: Integral IN XT

	Unit	IN 550 XT	IN 550 XTW	IN 750 XT
ACC area ①	°C	-50 – 220	-50 – 220	-45 – 220
Temperature stability ②	K	±0.05	±0.05	±0.05
Device dimensions: width x depth x height	mm	560 x 550 x 1325	560 x 550 x 1325	560 x 550 x 1325
Filling volume				
- Minimum	L	4.8	4.8	4.8
- Maximum	L	17.2	17.2	17.2
Pump data 50/60 Hz				
- Maximum discharge pressure	bar	3.1	3.1	3.1
- Maximum flow rate	l/min	65.0	65.0	65.0
Connector thread (outer) outflow/reverse flow	mm	M30 x 1.5	M30 x 1.5	M30 x 1.5
Noise level ③	dB(A)	65	60	65
Weight	kg	175.5	181.0	175.5
Distance between device and environment				
- Front	mm	500	200	500
- Back	mm	500	200	500

	Unit	IN 550 XT	IN 550 XTW	IN 750 XT
- Right	mm	500	200	500
- Left	mm	500	200	500

	Unit	IN 950 XTW	IN 1850 XTW
ACC area ①	°C	-50 – 220	-50 – 220
Temperature stability ②	K	±0.05	±0.05
Device dimensions: width x depth x height	mm	560 x 550 x 1325	760 x 650 x 1605
Filling volume			
- Minimum	L	4.8	8.0
- Maximum	L	17.2	28.6
Pump data 50/60 Hz			
- Maximum discharge pressure	bar	3.1	6.0
- Maximum flow rate	l/min	65.0	120.0
Connector thread (outer) outflow/reverse flow	mm	M30 x 1.5	M38 x 1.5
Noise level ③	dB(A)	60	60
Weight	kg	181.0	310.0
Distance between device and environment			
- Front	mm	200	200
- Back	mm	200	200
- Right	mm	200	200
- Left	mm	200	200

- ① - ACC area (Active Cooling Control) according to DIN 12876 is the working temperature range during operation with an active cooling unit.
- ② - Temperature stability determined according to standard DIN 12876
- ③ - Noise level determined according to standard EN 11201 for operating position in front of the device at 1 meter distance

13.2 Heating output and power supply

If the maximum current consumption is limited ↪ “Limiting the current consumption” on page 94, the heating output can be reduced.

Depending on the country-specific version, the maximum current consumption may already be limited ex works. Limited current consumption values are shown in brackets.

Integral IN XT

Table 54: Heating output, power supply and current consumption

	Unit	IN 550 XT	IN 550 XTW	IN 750 XT
Heating output 400 V; 3/PE; 50 Hz	kW	8.0	8.0	8.0
Current consumption	A	16.0	16.0	16.0

	Unit	IN 950 XT	IN 1850 XTW
Heating output 400 V; 3/PE; 50 Hz	kW	8.0	16.0
Current consumption	A	16.0	25.0

13.3 Cooling output



Measuring the performance data according to DIN 12876

The cooling capacity is measured at fixed temperatures of the heat transfer liquid. Ethanol is used as the standard heat transfer liquid, thermal oil is used for temperatures above 20 °C. The ambient temperature for the measurement of air-cooled devices is 20 °C. For the measurement of water-cooled devices the cooling water temperature is 15 °C as well as the cooling water differential pressure 3 bar.

All water-cooled devices are equipped with the following cooling water connection:

- Exterior thread (male) G ¾ inch

Integral XT with single-stage air-cooled cooling unit

Table 55: Cooling output

	Unit	IN 550 XT	IN 750 XT	Pump level
Cooling output at 200 °C	kW	5.00	7.00	8
100 °C	kW	5.00	7.00	8
20 °C	kW	5.00	7.00	8
10 °C	kW	4.80	6.30	8
0 °C	kW	4.60	4.80	8
-10 °C	kW	3.30	3.60	8
-20 °C	kW	2.40	2.60	4
-30 °C	kW	1.50	1.70	4
-40 °C	kW	0.70	0.85	4
-50 °C	kW	0.30	0.40	2

Integral XT with single-stage water-cooled cooling unit

Table 56: Cooling output

	Unit	IN 550 XTW	IN 950 XTW	IN 1850 XTW		Pump level
				50 Hz	60 Hz	
Cooling capacity (ambient temperature 20 °C)						
200 °C	kW	5.80	9.00	20.00	20.00	8
100 °C	kW	5.80	9.00	20.00	20.00	8
20 °C	kW	5.80	9.00	20.00	20.00	8
10 °C	kW	5.80	7.80	17.80	20.00	8
0 °C	kW	5.40	5.80	13.20	15.50	8
-10 °C	kW	4.00	4.20	9.40	10.80	8
-20 °C	kW	2.80	3.00	6.80	7.80	4
-30 °C	kW	1.70	1.90	4.20	5.40	4
-40 °C	kW	0.75	0.95	2.20	2.70	4
-50 °C	kW	0.35	0.50	1.35	1.60	2
Cooling water flow rate	l/min	8.0	20.0	26.0		---
Cooling water temperature minimum/maximum	°C	10/30	10/30	10/30		---
Recommended cooling water temperature	°C	15	15	15		---
Recommended cooling water pressure difference	bar	3.0	3.0	3.0		---
Minimum cooling water pressure difference*	bar	0.8	0.8	0.8		---
Maximum cooling water pressure difference*	bar	10.0	10.0	10.0		---
Maximum cooling water pressure	bar	10.0	10.0	10.0		---

* only approved for a max. cooling water temperature of 20 °C

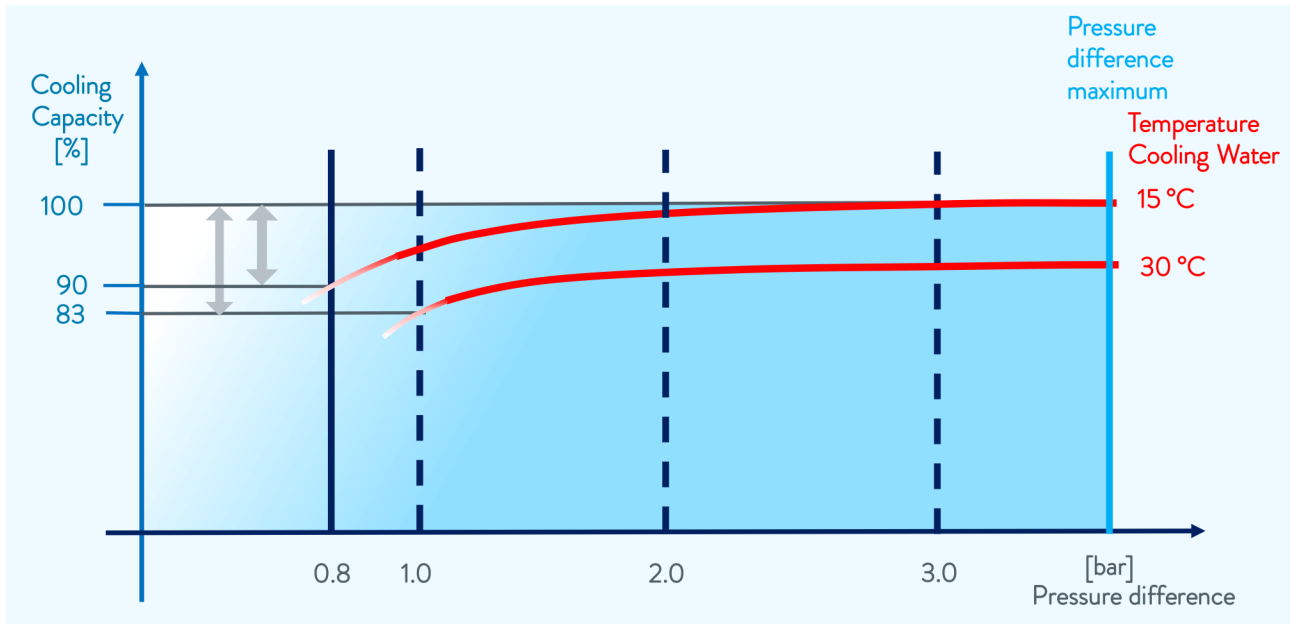

Fig. 88: Cooling water pressure difference

13.4 Refrigerant and filling weight

Integral IN XT with single-stage cooling unit

	Unit	IN 550 XT	IN 550 XTW	IN 750 XT
Refrigerant	---	R-290	R-290	R-290
Maximum filling weight	kg	0.35	0.45	0.35
GWP _(100a) *	---	3	3	3
CO ₂ equivalent	kg	1.05	1.35	1.05

	Unit	IN 950 XTW	IN 1850 XTW
Refrigerant	---	R-290	R-1270
Maximum filling weight	kg	0.45	0.925
GWP _(100a) *	---	3	2
CO ₂ equivalent	kg	1.35	1.85



Global Warming Potential (GWP), CO₂ comparison = 1.0

* Time frame 100 years - according to IPCC IV

13.5 Pump characteristics for IN XT

Pump levels 1 - 8, measured with water

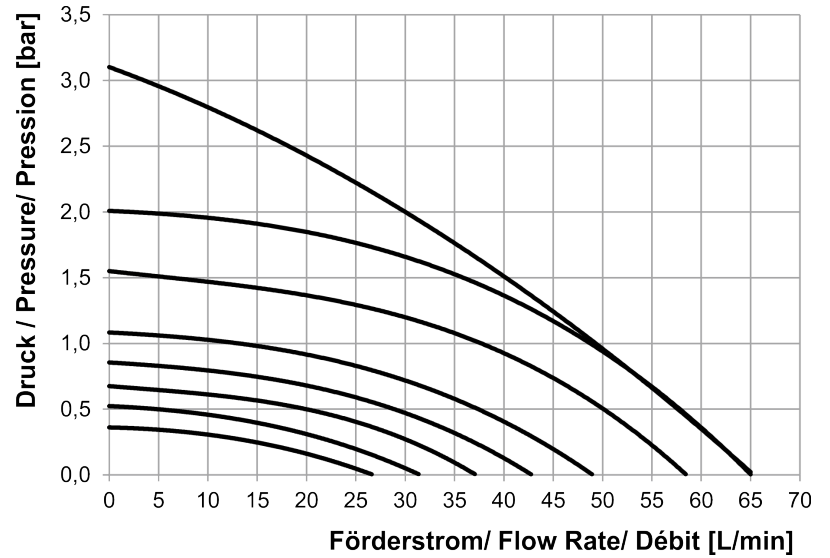

Fig. 89: all devices \leq than IN 950 XTW

Pump levels 1 - 8, measured with water

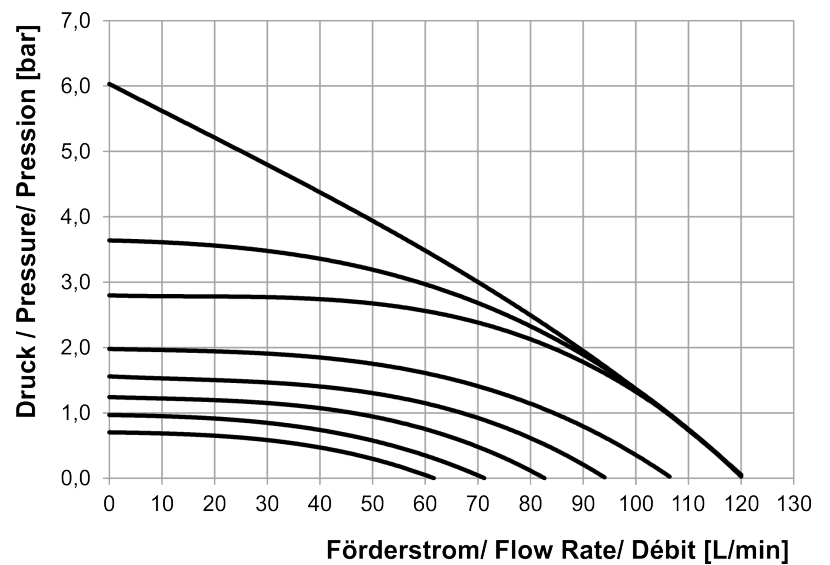
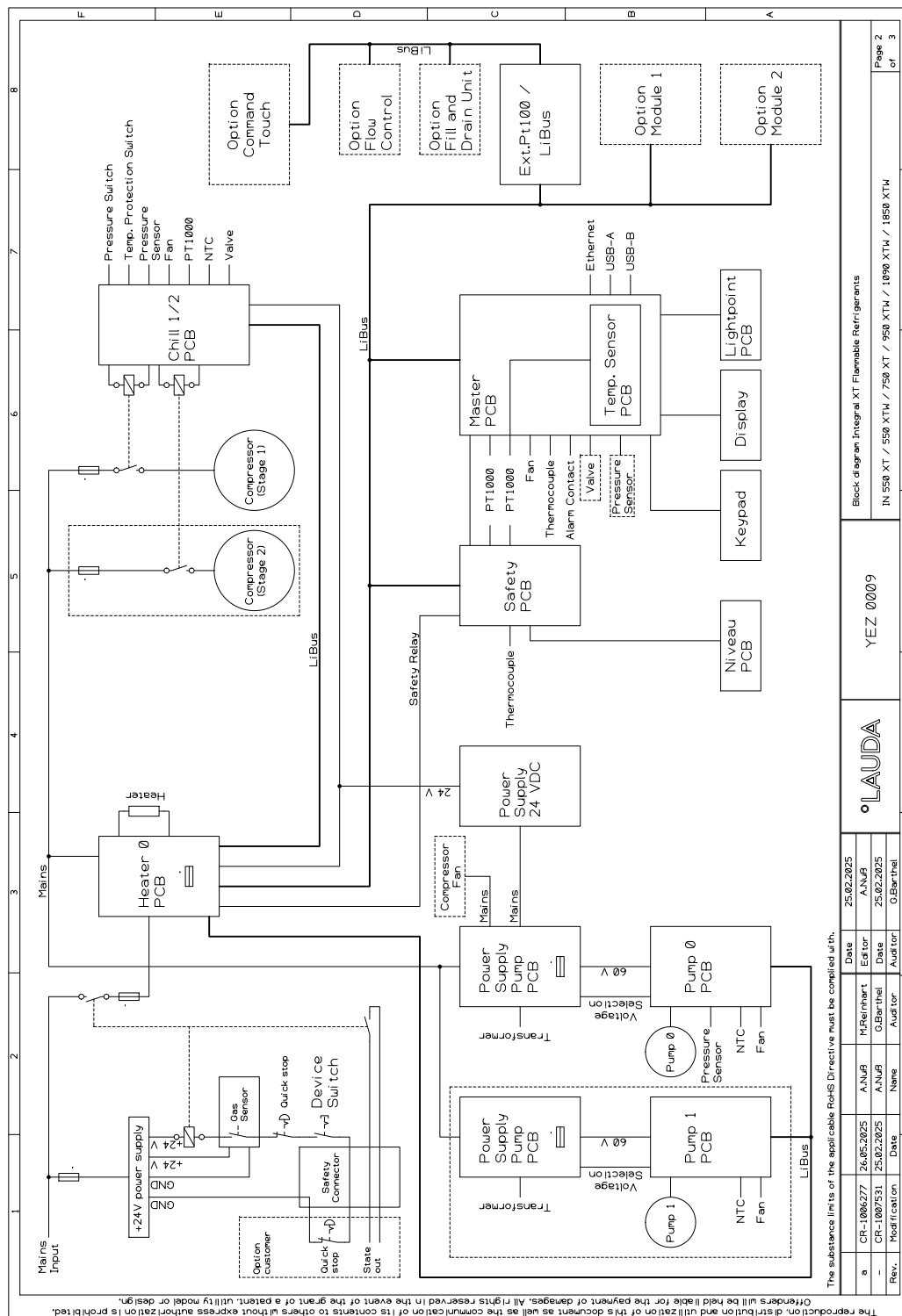

Fig. 90: IN 1850 XTW

13.6 Electrical block diagram



The reproduction, distribution and utilization of this document as well as the communication of its contents to others without express authorization is prohibited. Offenders will be held liable for the payment of damages. All rights reserved in the event of the grant of a patent, utility model or design.

Block diagram, Integral XT Flammable Refrigerants

IN 550 XT / 550 XTM / 750 XT / 950 XTM / 1090 XTM / 1850 XTM

Page 2 of 3

14 Declaration of Conformity



EC DECLARATION OF CONFORMITY

Manufacturer: LAUDA DR. R. WOBSE GMBH & CO. KG
Laudaplatz 1, 97922 Lauda-Königshofen, Germany

We hereby declare under our sole responsibility that the machines described below

Product line: Integral **Serial number:** from S2600000001

Types: IN 550 XT, IN 550 XTW, IN 750 XT, IN 950 XTW, IN 1850 XTW
(versions with refrigerants with safety class A3 in accordance with ISO 817)

comply with all relevant provisions of the following EC directives and regulations due to their design and construction in the version marketed by us:

Machinery Regulation	(EU) 2023/1230 (valid from 20.01.2027)
Machinery Directive	2006/42/EU (valid until 19.01.2027)
Pressure Equipment Directive	2014/68/EC Module A2
EMC Directive	2014/30/EC
RoHS Directive	2011/65/EC in conjunction with (EC) 2015/863

The protection objectives of the Machinery Regulation (or Directive) with regard to electrical safety are complied with in accordance with Annex III (or Annex I) paragraph 1.5.1 with conformity to the Low Voltage Directive 2014/35/EU.

Notified body according to the Pressure Equipment Directive:

BUREAU VERITAS SERVICES SAS
Address: 4, Place des Saisons, 92400 COURBEVOIE, France
Number of the notified body: 0062
Certificate: CE-0062-PED-A2-LDA 001-25-DE
List of components of the assemblies: See appendix.

Standards applied (date of publication in the Official Journal of the European Union is given in brackets if applicable):

- EN ISO 12100:2010 (exp. 08.04.2011)
- EN 61010-1:2010/A1:2019/AC:2019-04 (exp. 30.11.2020)
- EN 61326-1:2021
- EN 61326-3-1:2017
- EN IEC 61010-2-010:2020 (exp. 22.06.2021)
- EN 378-2:2016 (exp. 09.06.2017)

Authorized representative for the compilation of technical documentation:
Dr. Jürgen Dirscherl, Head of Research & Development

Signed for and on behalf of: LAUDA DR. R. WOBSE GMBH & CO. KG

Lauda-Königshofen, 04.03.2026

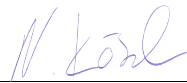

Nina Kössel,
Director Quality and Environmental Management

Annex to the EC Declaration of Conformity in accordance with the Pressure Equipment Directive 2014/68/EU:

List of components of the assembly.

Heat transfer circuit :

Art. 4 para. 3

Cooling water circuit:

Art. 4 para. 3

Refrigeration circuit HD:

Designation of component (pressure equipment)	Manufacturer	Fluid group	PS [bar]	Volume [l] / DN	Category	Evaluation procedure	TS min. [°C]
Material/type		Condition					TS max. [°C]
Pressure switch	Johnson Controls	Fluid group 1	23,5	-	Cat. VI	Module B+D	-53
		Gas					135

Refrigeration circuit ND:

Designation of component (pressure equipment)	Manufacturer	Fluid group	PS [bar]	Volume [l] / DN	Category	Evaluation procedure	TS min. [°C]
Material/type		Condition					TS max. [°C]
Compressor ZB20-KCU	Copeland	Fluid group 1	14	4,3	Cat. II	Module A2	-35
		Gas					50
Compressor YF26K1S	Copeland	Fluid group 1	23,5	6,4	Cat. II	Module A2	-35
		Gas					55

15 Product Returns and Clearance Declaration

Product Returns

Would you like to return a LAUDA product you have purchased to LAUDA? For the return of goods, e.g. for repair or due to a complaint, you will need the approval of LAUDA in the form of a *Return Material Authorization (RMA)* or *processing number*. You can obtain the RMA number from our customer service department at +49 (0) 9343 503 350 or by email service@lauda.de.

Return address

LAUDA DR. R. WOBSE GMBH & CO. KG
Laudaplatz 1
97922 Lauda-Königshofen
Deutschland/Germany

Clearly label your shipment with the RMA number. Please also enclose this fully completed declaration.

RMA number	Product serial number
Customer/operator	Contact name
Contact email	Contact telephone
Zip code	Place
Street & house number	
Additional explanations	

Clearance Declaration

The customer/operator hereby confirms that the product returned under the above-mentioned RMA number has been carefully emptied and cleaned, that any connections have been sealed to the farthest possible extent, and that there are no explosive, flammable, environmentally hazardous, biohazardous, toxic, radioactive or other hazardous substances in or on the product.

Place, date	Name in block letters	Signature

16 Glossary

Auto IP	Auto IP is a standardized procedure where two or more participants agree on the same network configuration.
DHCP Client (Dynamic Host Configuration Protocol Client)	A DHCP client facilitates the automatic integration of an Ethernet interface in an existing network. As a result, the interface does not have to be manually integrated in the existing network.
DNS server (Domain Name Service Server)	The Domain Name Service is a database where mainly information on names and IP addresses of the computer are stored. A DNS can, for example, disperse a web address or URL (Uniform Resource Locator) to an IP address. The Ethernet interface specifies the IP address of the DNS server present in the connected network.
Gateway	Various networks are connected with one another via a gateway. Here, an IP address is given that can be used to reach a gateway in a local network.
IP address (Internet Protocol Address)	Each device within a data network requires an address, so that it can be clearly identified. This is the only way to ensure that e.g. the data flow is received by the correct device. When an Internet page is opened, the browser always transfers the IP address of your device. This is the only way that the web server can know where to send the required data packet. The Internet Protocol (IP) is a widely adopted network standard that stipulates how information can be exchanged.
IP version	Provides information about the Internet standard: IPv4 or IPv6. A well-known example of an IP address is 192.168.0.1. This address is structured according to the IPv4 standard: Four numbers between 0 and 255, whereby a period separates the numbers from one another. However, this system only allows a limited number of combinations, which is why there are IP addresses structured according to the standard in version 6 (IPv6). They consist of eight blocks of characters that can contain both numbers and letters as shown in this example: fe80:0010:0000:0000:0000:0000:0000:0001. Because this can seem rather confusing, a long string of zeros can be replaced by a colon. The IPv6 address from the example would therefore appear in a shortened form as follows: fe80:0010::1.
Local IP address	The local IP address is an address for the Ethernet interface in the local network. The Ethernet interface in the local network can be reached using this address. If the DHCP client is deactivated, the local IP address and the local mask must be manually configured. For manual configuration start by contacting your IT department.
Local mask	Local (subnet) masks are used to flexibly adapt the rigid class division of IP addresses in networks and computers to actual conditions.
MAC (Media Access Control)	Media Access Control is an almost unique global hardware address which can be used to clearly identify the device in an Ethernet network.
NTP (Network Time Protocol)	Network time protocol is a standard for synchronizing the time and date in networks.
Port	Port is a number that is used to establish a connection between two network participants. The port is a part of the network address. The port for the Ethernet interface can be taken from the approved "dynamic ports" range. This lies between 49152 and 65535.

Process Interface

A process interface on the LAUDA constant temperature equipment is the interface that makes it possible to control or monitor the constant temperature equipment via Ethernet using LAUDA interface command sets.

TCP (Transmission Control Protocol)

This network protocol define how data is exchanged between network components.

17 Index

- A**
- Accessories 154
 - In series 18
 - Modules 154
 - Actual temperature (display) 62
 - Adaptation process 112
 - Adjusting the brightness (display) 93
 - Adjusting the display brightness 93
 - Adjusting the volume (sound) 92
 - Adjustment time 114, 116
 - Air-cooled
 - Cleaning the condenser 135
 - Alarm 143
 - Codes 146
 - Description 144
 - Application
 - connect 32
 - Attenuation time 114, 116
 - Autostart
 - Activating 93
 - Deactivating 93
- B**
- Bypass
 - internal 74
- C**
- Calibrate (actual temperature)
 - Determine 95
 - Calibration in the factory 95
 - Certificate
 - CA 124
 - Download 124
 - Change
 - Heat transfer liquid 150
 - changed
 - Sounds 92
 - Checking
 - Heat transfer liquid 140
 - Low-level protection 139
 - Overtemperature protection 138
 - Tmax 138
 - Cleaning 135
 - Cloud 126
 - CO₂ equivalent 163
 - Code
 - Alarms 146
 - Configuring the alarm output 40
 - Consumer
 - connect 32
 - Contact 156
 - Control
 - Defining the controller output limit 88
 - Control parameter
 - Defining correction limitation 118
 - External (overview) 117
 - Control parameters
 - Changing 119
 - Internal (overview) 116
 - Control variable
 - Activation 118
 - Cookies 125
 - Cooling
 - Without reheating 90
 - Cooling unit
 - Setting 90
 - single-stage 160, 162
 - Cooling water
 - Connecting 40
 - Connection information 40
 - Pressure 40, 161
 - Requirements 37
 - Setting 40
 - Temperature 40, 161
 - Cooling water circuit
 - Draining 138, 151
 - Copyright 155
 - Correction limit 117
 - Correction limitation 114, 117

Corrugated metal hose	30	Disposing of refrigerant	153
Cracking	88	Draining	
D		Cooling water circuit	138, 151
Damping time	117	Device	149
Dead-time correction	89	Drum pump	72
Defining the language (display)	94	E	
Defining the menu language	94	Emissions class	10
Degassing		Enter	
Automatic	73	Temperature	65
Compressed air	73	Entry window	
Inert gas	73	Entering a value	65
Mode	73	Selecting options	64
Descaling	137	Structure	64
Device		Error	143
Cleaning	135	Description	144
Cleaning condenser (air-cooled)	135	Read out memory	98
Decontamination	135	Error messages	57
Displaying serial numbers	99	Establishing a mains connection	59
Disposal (packaging)	153	Establishing a power supply	59
Disposal (refrigerant)	153	Ethernet	
Draining	149	Setting	42
Filling	70, 71	External consuming unit	
Installation	29	connect	32
Read out memory	98	External control	
Structure	22	Defining the setpoint offset	87
Switching on	60	F	
Unpacking	18	Factory calibration	95
Viewing data	98	Factory setting	
DIN EN 378-1	12	Cooling	90
Display	93	Restore	96, 97
Home window (structure)	62	Fault	143
Soft key bar	62	FC 80 C	89, 154
Status bar (structure)	62	FC 80 MID	89, 154
temperature	62	Filling	70, 71
Temperatures	93	Flow controller	89
Displaying serial numbers (device)	99	Fluid	68
Disposal		G	
Ethanol	153	Gain factor	117
Liquid	153	GNU	155
Packaging	153		
Refrigerant	153		

Graph	
Window (structure)	65
GWP	163
H	
Hardware version	99
Heat transfer liquid	
Change	150
Checking	140
Disposal	153
Removal	149
Safety data sheet	36
Heating	
Limitation	90
Heating output	
reduction	88
Hold-back time	114, 116
Home window	
START	62
STOP	62
Structure	62
Hose	30
HyperTerminal	44
I	
ID	124
Immunity	10
Improper use	11
Installation	
Device	29
Intended use	11
Interface functions	
Read commands	48
Write commands	54
IP	124
K	
Keep-alive	120
Kpe	117
L	
LAUDA.LIVE	
Access	126
Cloud	126
Lead time	117
License texts	155
Light point	62
Limitation	
Heating	90
Limits (temperature)	
Setting	91
Liquid	
Disposal	153
Lock	
Buttons	91
Lock the entry functions	91
Lock the operating button	91
Low-level protection	
Checking	139
Definition	17
M	
Maintenance	
Intervals	134
Maximum temperature	138
MID	89, 154
MIT	155
Modules	
Accessories	154
O	
Offset (actual temperature)	
Calibrate	95
Operator	120
OUT	
Contact	40
Overtemperature protection	
Definition	16
Overtemperature switch-off point	
Setting	87
P	
Packaging	
Disposal	153
Personal protective equipment (overview)	15
Personnel qualification (overview)	15

Power failure	93	Service	156
Pressure control	74	Set time	112
Pressure pump	72	Setting the current consumption	94
Program		single-stage cooling unit	162
Create	105	Softkey bar (display)	62
Edit	105	Software version	99
Example	100	Sound (adjusting)	92
Program optimization		Start	
Description	100	Segment	103
Prop_E	117	Status bar (display)	62
Proportional range	114, 116, 117	Structure	
Protective equipment (personal, overview)	15	Device	22
Pump		Switching on	60
Selecting the flow rate level	74	Symbol	
Selecting the level	74	Cloud	126
Selecting the output level	74	T	
Pump characteristic curve	164	Td	114, 116
R		Tde	117
Ramp function	107	Technical data	157
Read commands	48	Pump characteristic curve	164
Read privileges	120	Temperature	
Reading out memory (error)	98	Enter	65
Refrigerant		Temperature limits	
Filling charge	163	Setting	91
Filling weight	163	Terminal program	44
Flammable	12	Three-phase motor	
Repair	143	Direction of rotation	59
Reset time	117	Throttle	74
S		Tih, Til	91
Safe Mode		Til, Tih	91
Activated	128	Time period	47
Switch on	128	Time zone	112
Safety data sheet		Tmax	
Download	36	Checking	138
Heat transfer liquid	36	Setting	87
Safety information	7	TmaxTank	87
Segment		Tn	114, 116
Start	103	Tne	117
Segments	105	Tv	114, 116
Serial numbers	24, 124	Tve	117

U	
Unpacking	18
USB	26
V	
Version (software)	99
Viewer	120
Viewing configuration data (device)	98
W	
Warning	143
Description	144
Warranty	155
Write commands	54
Write privileges	120
X	
Xp	114, 116
Xpf	117
Y	
Year of construction	24

Manufacturer:

LAUDA DR. R. WOBSE GMBH & CO. KG ° Laudaplatz 1 ° 97922 Lauda-Königshofen

Telephone: +49 (0)9343 503-0

E-mail: info@lauda.de ° Internet: <https://www.lauda.de>